

TPS7B69xx-Q1 High-Voltage Ultra-Low I_Q Low-Dropout Regulator

1 Features

- Qualified for Automotive Applications
- AEC-Q100 Qualified With the Following Results:
 - Device Temperature Grade 1: -40°C to 125°C Ambient Operating Temperature Range
 - Device HBM ESD Classification Level 2
 - Device CDM ESD Classification Level C4B
- 4 to 40-V Wide V_I Input Voltage Range With up to 45-V Transient
- Maximum Output Current: 150 mA
- Low Quiescent Current (I_Q):
 - 15 μA Typical at Light Loads
 - 25 μA Maximum Under Full Temperature
- 450-mV Typical Low Dropout Voltage at 100 mA Load Current
- Stable With Low ESR Ceramic Output Capacitor (2.2 to 100 μF)
- Fixed 2.5-V, 3.3-V, and 5-V Output Voltage Options
- Integrated Fault Protection:
 - Thermal Shutdown
 - Short-Circuit Protection
- Packages:
 - 4-Pin SOT-223 Package
 - 5-Pin SOT-23 Package

2 Applications

- Automotive
- Infotainment Systems With Sleep Mode
- Always-On Battery Applications
 - Door Modules
 - Remote Keyless-Entry Systems
 - Immobilizers

3 Description

The TPS7B69xx-Q1 device is a low-dropout linear regulator designed for up to 40-V V_I operations. With only 15- μA (typical) quiescent current at light load, the device is suitable for standby microcontrol-unit systems especially in automotive applications.

The devices feature an integrated short-circuit and overcurrent protection. The TPS7B69xx-Q1 device operates over a -40°C to 125°C temperature range. Because of these features, the TPS7B6925-Q1, TPS7B6933-Q1, and TPS7B6950-Q1 devices are well suited in power supplies for various automotive applications.

Device Information⁽¹⁾

PART NUMBER	PACKAGE	BODY SIZE (NOM)
TPS7B6925-Q1	SOT-223 (4)	6.50 mm x 3.50 mm
TPS7B6933-Q1	SOT-23 (5)	2.90 mm x 1.60 mm
TPS7B6950-Q1		

(1) For all available packages, see the orderable addendum at the end of the datasheet.

4 Typical Application Schematic

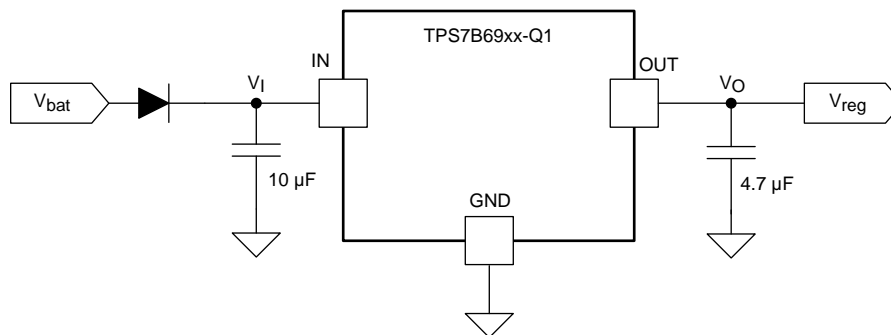

Table of Contents

1 Features	1	8.3 Feature Description	10
2 Applications	1	8.4 Device Functional Modes	11
3 Description	1	9 Application and Implementation	12
4 Typical Application Schematic	1	9.1 Application Information	12
5 Revision History	2	9.2 Typical Application	12
6 Pin Configuration and Functions	3	10 Power Supply Recommendations	14
7 Specifications	4	11 Layout	14
7.1 Absolute Maximum Ratings	4	11.1 Layout Guidelines	14
7.2 ESD Ratings	4	11.2 Layout Example	14
7.3 Recommended Operating Conditions	4	12 Device and Documentation Support	15
7.4 Thermal Information	4	12.1 Documentation Support	15
7.5 Electrical Characteristics	5	12.2 Related Links	15
7.6 Typical Characteristics	6	12.3 Trademarks	15
8 Detailed Description	10	12.4 Electrostatic Discharge Caution	15
8.1 Overview	10	12.5 Glossary	15
8.2 Functional Block Diagram	10	13 Mechanical, Packaging, and Orderable Information	15

5 Revision History

Changes from Revision A (December 2014) to Revision B Page

- Changed the TPS7B6933-Q1 device status from *Product Preview* to *Production Data* **1**
- Added the TPS7B6933-Q1 device test results to the *Typical Characteristics* section **6**

Changes from Original (November 2014) to Revision A Page

- Changed the device status from *Product Preview* to *Production Data* **1**

6 Pin Configuration and Functions

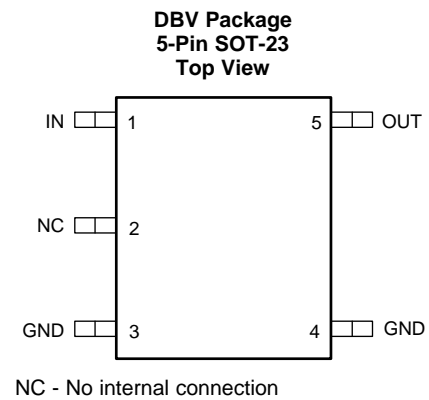
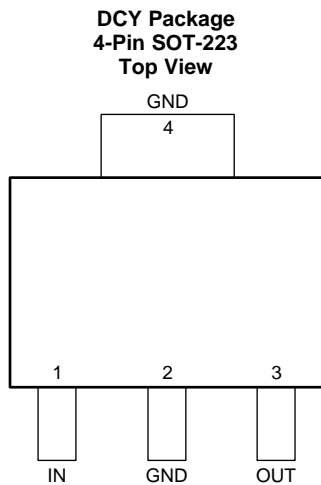

Pin Functions

NAME	PIN NO.		TYPE	DESCRIPTION
	SOT-223	SOT-23		
GND	2	3	G	Ground reference
	4	4		
IN	1	1	P	Input power-supply voltage
NC	—	2	—	Not connected pin
OUT	3	5	P	Output voltage

7 Specifications

7.1 Absolute Maximum Ratings

 over operating free-air temperature range (unless otherwise noted)⁽¹⁾

		MIN	MAX	UNIT
Unregulated input voltage	IN ⁽²⁾⁽³⁾⁽⁴⁾	-0.3	45	V
Regulated output voltage	OUT ⁽²⁾⁽³⁾	-0.3	7	V
Operating junction temperature range, T _J		-40	150	°C
Storage temperature, T _{stg}		-65	150	°C

- (1) Stresses beyond those listed under *Absolute Maximum Ratings* may cause permanent damage to the device. These are stress ratings only, which do not imply functional operation of the device at these or any other conditions beyond those indicated under *Recommended Operating Conditions*. Exposure to absolute-maximum-rated conditions for extended periods may affect device reliability.
- (2) All voltage values are with respect to the GND terminal.
- (3) Absolute negative voltage on these pins must not go below -0.3 V.
- (4) Absolute maximum voltage, withstands 45 V for 200 ms.

7.2 ESD Ratings

			VALUE	UNIT
V _(ESD)	Electrostatic discharge	Human body model (HBM), per AEC Q100-002 ⁽¹⁾		±2000
		Charged device model (CDM), per AEC Q100-011	Other pins	±500
			Corner pins (4 pin: 1, 3, and 4; 5 pin: 1, 3, 4, and 5)	±750

- (1) AEC Q100-002 indicates HBM stressing is done in accordance with the ANSI/ESDA/JEDEC JS-001 specification.

7.3 Recommended Operating Conditions

over operating free-air temperature range (unless otherwise noted)

		MIN	MAX	UNIT
V _I	Unregulated input voltage	4	40	V
V _O	Output voltage	0	5.5	V
C _O	Output capacitor requirements ⁽¹⁾	2.2	100	μF
ESR _{CO}	Output ESR requirements ⁽²⁾	0.001	2	Ω
T _J	Operating junction temperature range	-40	150	°C

- (1) The output capacitance range specified in this table is the effective value.
- (2) Relevant ESR value at $f = 10$ kHz.

7.4 Thermal Information

THERMAL METRIC ⁽¹⁾⁽²⁾		DCY 4 PINS	DBV 5 PINS	UNIT
R _{θJA}	Junction-to-ambient thermal resistance	64.2	210.4	°C/W
R _{θJC(top)}	Junction-to-case (top) thermal resistance	46.8	126.1	
R _{θJB}	Junction-to-board thermal resistance	13.3	38.4	
ψ _{JT}	Junction-to-top characterization parameter	6.3	16	
ψ _{JB}	Junction-to-board characterization parameter	13.2	37.5	

- (1) The thermal data is based on the JEDEC standard high-K profile, JESD 51-7, 2s2p four layer board with 2-oz copper. The copper pad is soldered to the thermal land pattern. Also correct attachment procedure must be incorporated.
- (2) For more information about traditional and new thermal metrics, see the *IC Package Thermal Metrics* application report, [SPRA953](#).

7.5 Electrical Characteristics

 $V_{IN} = 14\text{ V}$, $1\text{ m}\Omega < \text{ESR} < 2\ \Omega$, $T_J = -40^\circ\text{C}$ to 150°C (unless otherwise noted)

PARAMETER	TEST CONDITIONS	MIN	TYP	MAX	UNIT		
SUPPLY VOLTAGE AND CURRENT (IN)							
V_I	Input voltage	Fixed 2.5-V output, $I_O = 1\text{ mA}$		4	40	V	
		Fixed 3.3-V output, $I_O = 1\text{ mA}$		4	40		
		Fixed 5-V output, $I_O = 1\text{ mA}$		5.5	40		
I_Q	Quiescent current	Fixed 2.5-V and 3.3-V version, $V_I = 4$ to 40 V , Fixed 5-V version, $V_I = 5.5$ to 40 V , $I_O = 0.2\text{ mA}$			15	25	μA
$V_{IN(UVLO)}$	IN undervoltage detection	Ramp V_I up until the output turns on		3.65		V	
		Ramp V_I down until the output turns OFF			3		
REGULATED OUTPUT (OUT)							
V_O	Regulated output	Fixed 2.5-V version, $V_I = 4$ to 40 V , $I_O = 1$ to 150 mA		-3%	3%		
		Fixed 3.3-V version, $V_I = 5$ to 40 V , $I_O = 1$ to 150 mA		-3%	3%		
		Fixed 5-V version, $V_I = 6.5$ to 40 V , $I_O = 1$ to 150 mA		-3%	3%		
$\Delta V_{O(\Delta V_I)}$	Line regulation	$V_I = 6$ to 40 V , ΔV_O , $I_O = 10\text{ mA}$			10	mV	
$\Delta V_{O(\Delta I_L)}$	Load regulation	$I_O = 1$ to 150 mA , ΔV_O			20	mV	
V_{DROPO}	Dropout voltage	Fixed 2.5-V version, $V_I - V_O$, $I_O = 50\text{ mA}$			1.575	V	
		Fixed 2.5-V version, $V_I - V_O$, $I_O = 100\text{ mA}$			1.575		
		Fixed 3.3-V version, $V_I - V_O$, $I_O = 50\text{ mA}$			799	mV	
		Fixed 3.3-V version, $V_I - V_O$, $I_O = 100\text{ mA}$			800		
		Fixed 5-V version, $V_I - V_O$, $I_O = 50\text{ mA}$			220		400
		Fixed 5-V version, $V_I - V_O$, $I_O = 100\text{ mA}$			450		800
I_O	Output current	V_O in regulation		0	150	mA	
I_{OCL}	Output current-limit	OUT short to ground		150	500	mA	
PSRR	Power supply ripple rejection ⁽¹⁾	$V_{rip} = 0.5\text{ V}_{pp}$, Load = 10 mA , $f = 100\text{ Hz}$, $C_O = 2.2\ \mu\text{F}$			60	dB	
OPERATING TEMPERATURE RANGE							
T_{sd}	Junction shutdown temperature		175		$^\circ\text{C}$		
T_{hys}	Hysteresis of thermal shutdown		25		$^\circ\text{C}$		

(1) Design Information—Not tested, ensured by characterization.

7.6 Typical Characteristics

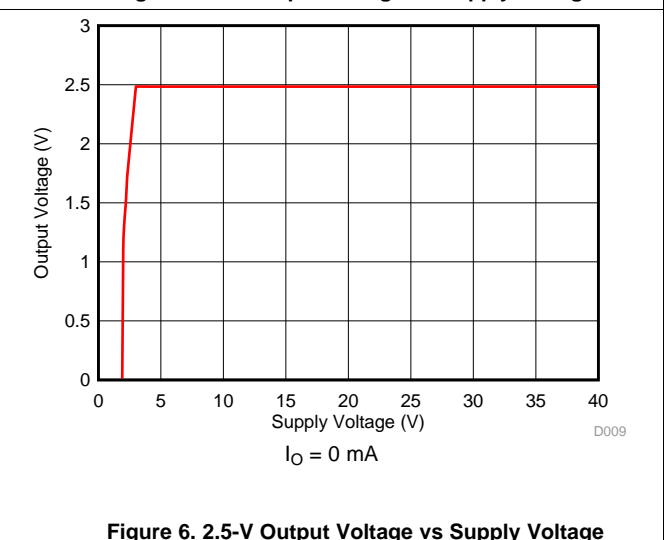
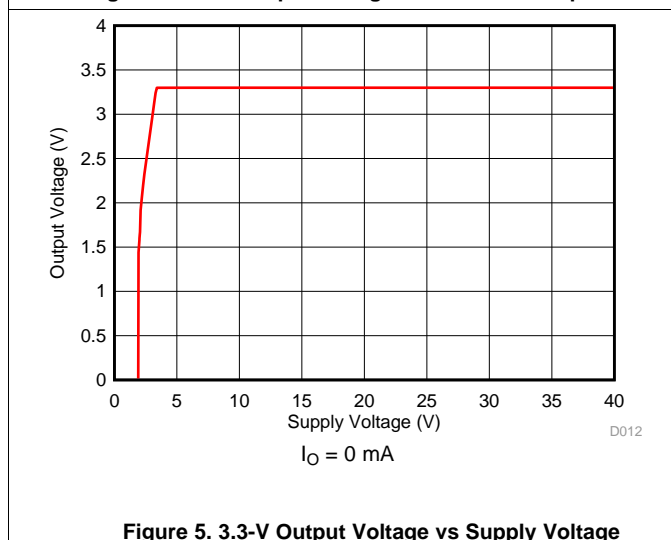
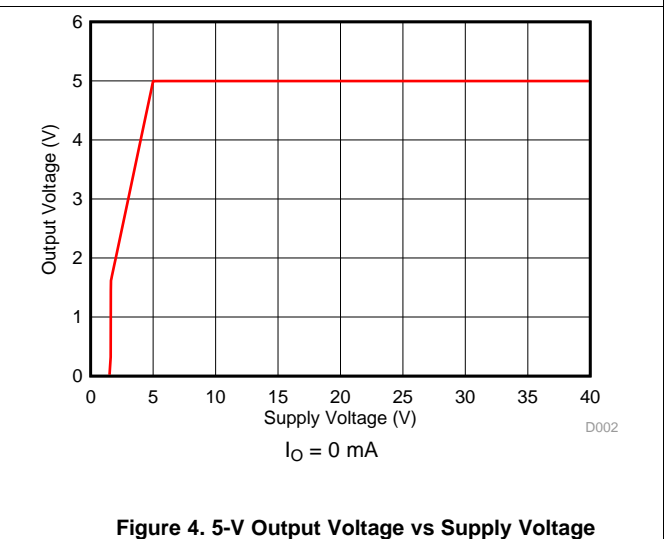
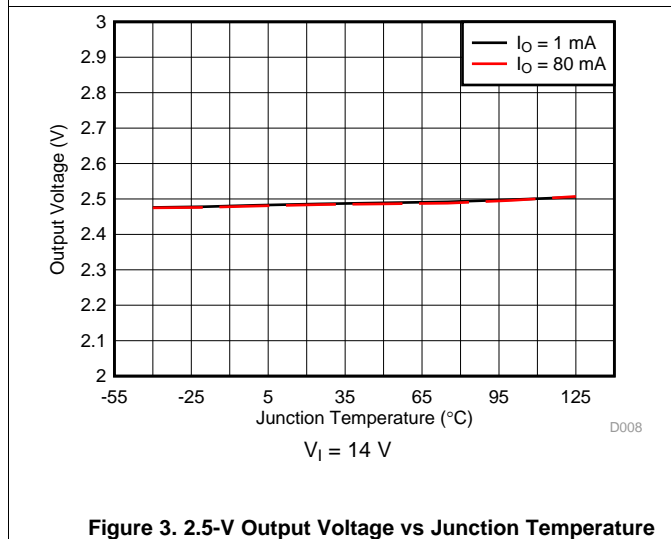
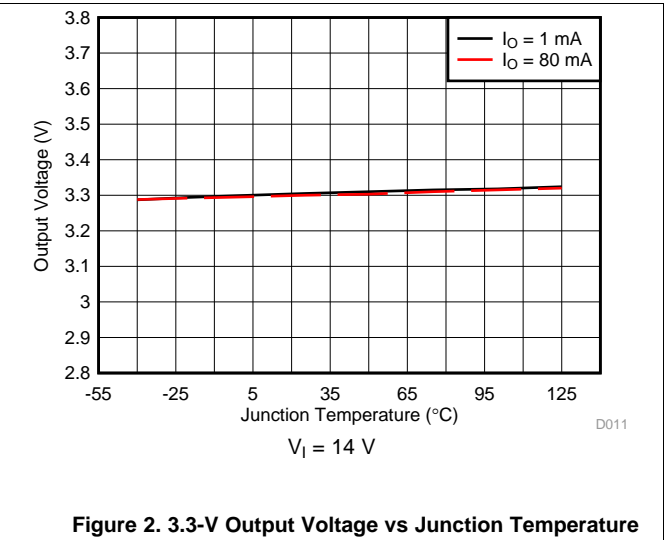
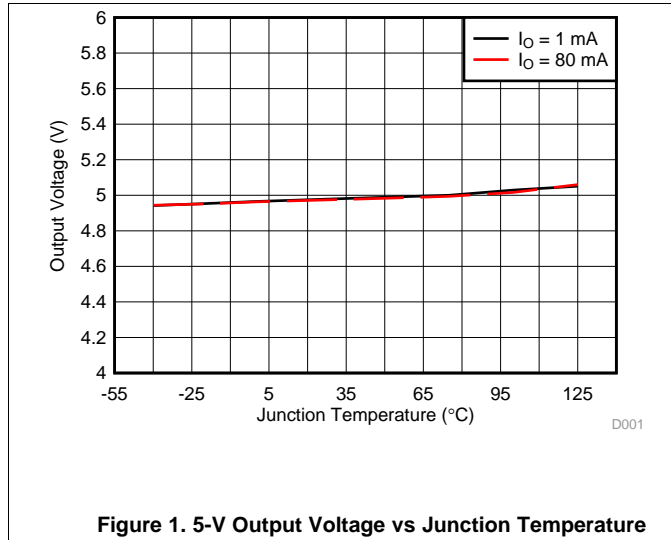

Typical Characteristics (continued)

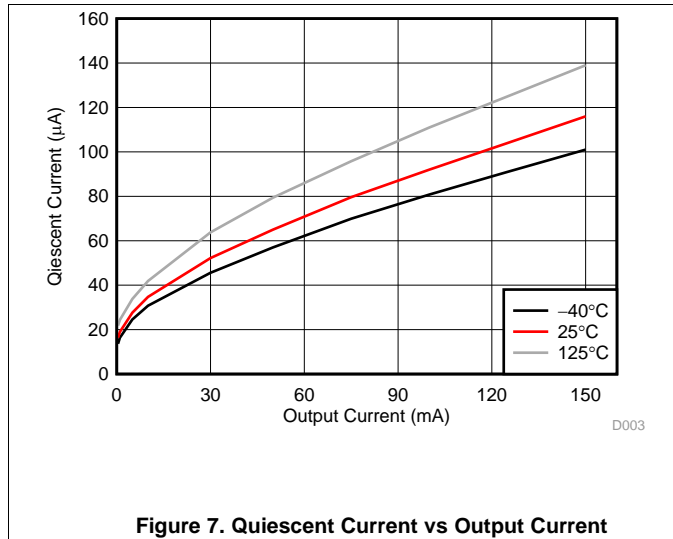

Figure 7. Quiescent Current vs Output Current

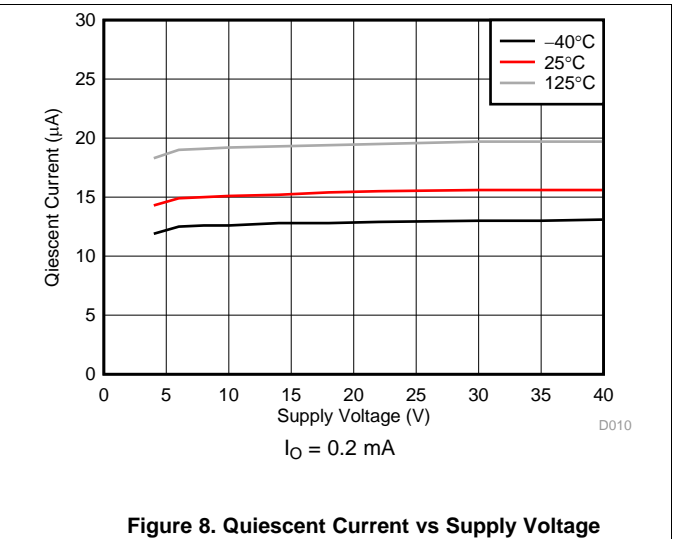

Figure 8. Quiescent Current vs Supply Voltage

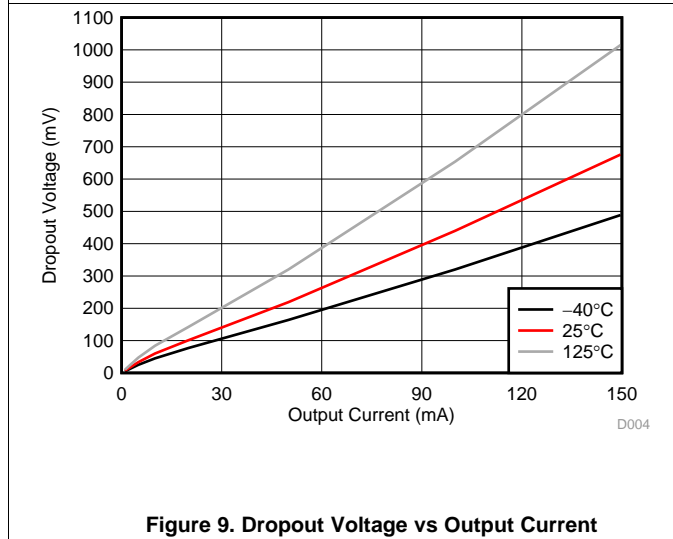

Figure 9. Dropout Voltage vs Output Current

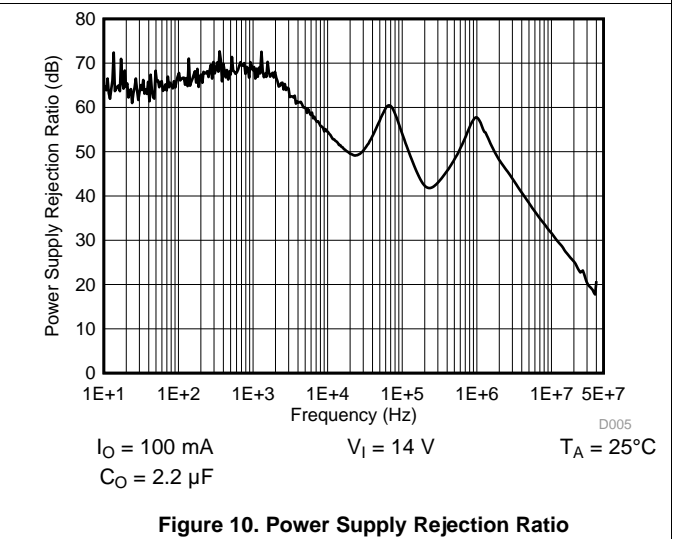

Figure 10. Power Supply Rejection Ratio

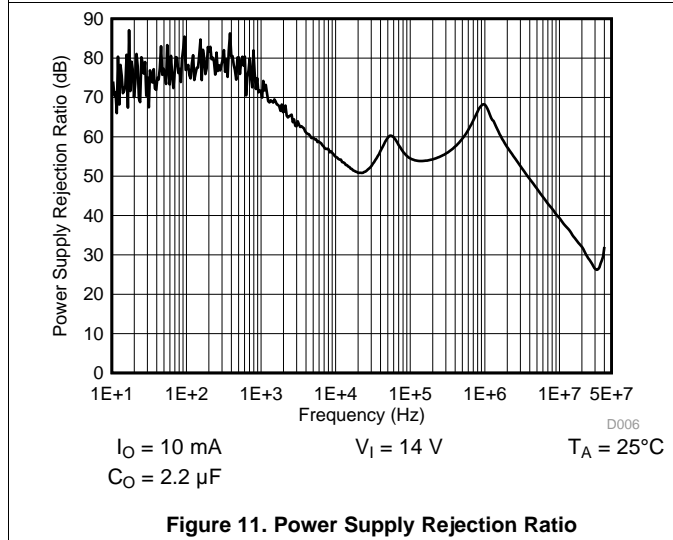

Figure 11. Power Supply Rejection Ratio

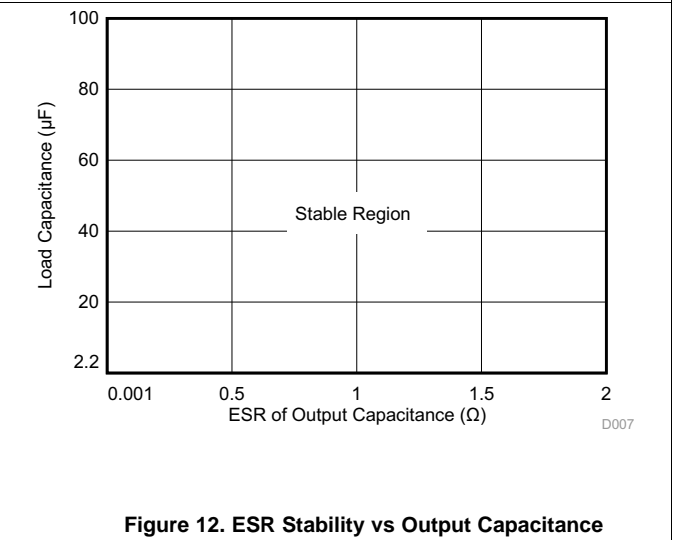

Figure 12. ESR Stability vs Output Capacitance

Typical Characteristics (continued)

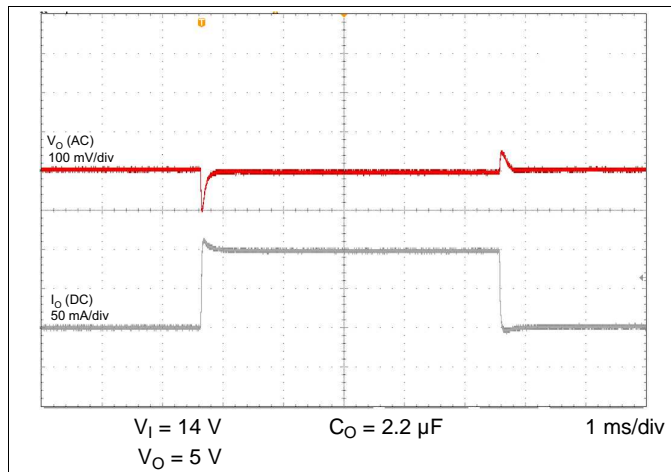

Figure 13. Load Transient (1 to 100 mA, 5 V)

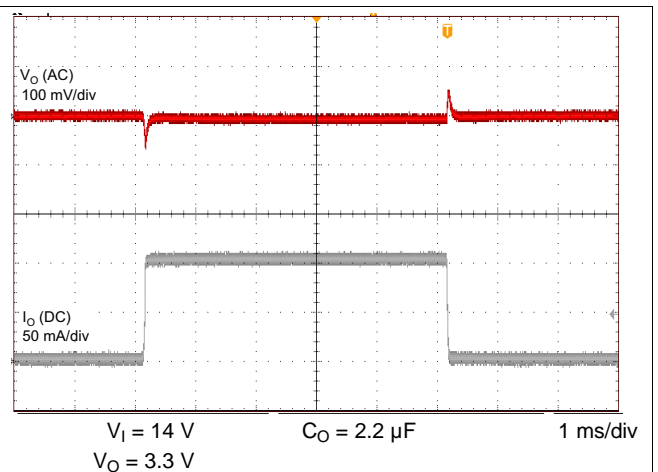

Figure 14. Load Transient (1 to 100 mA, 3.3 V)

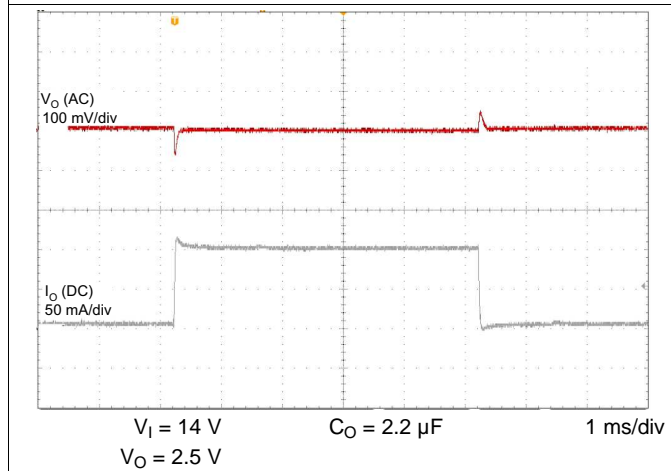

Figure 15. Load Transient (1 to 100 mA, 2.5 V)

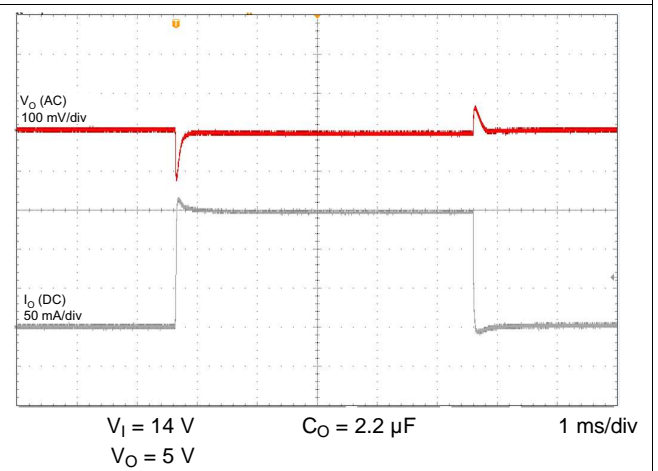

Figure 16. Load Transient (1 to 150 mA, 5 V)

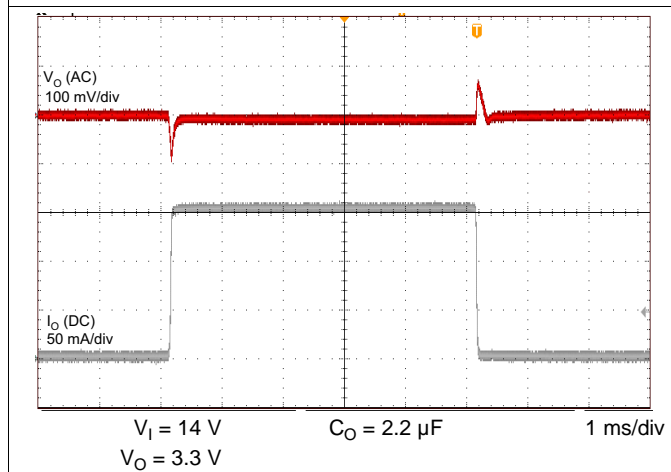

Figure 17. Load Transient (1 to 150 mA, 3.3 V)

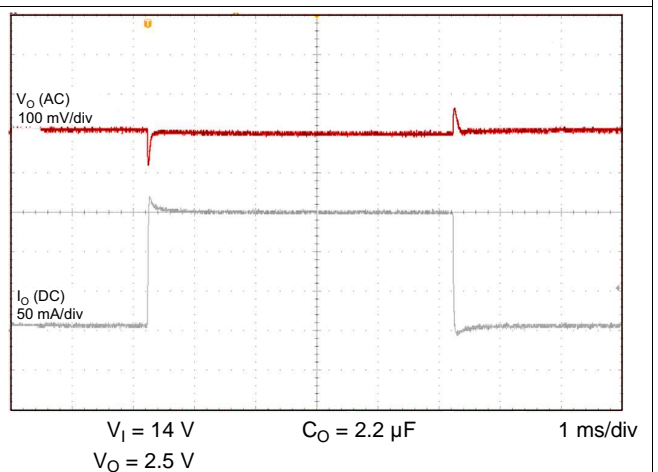

Figure 18. Load Transient (1 to 150 mA, 2.5 V)

Typical Characteristics (continued)

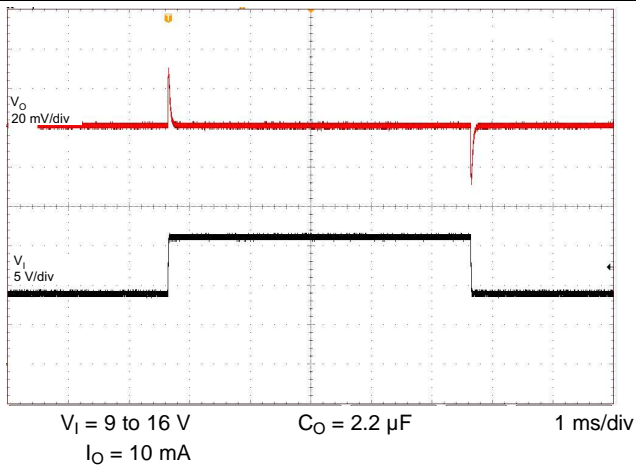

Figure 19. Line Transient ($V_O = 5\text{ V}$)

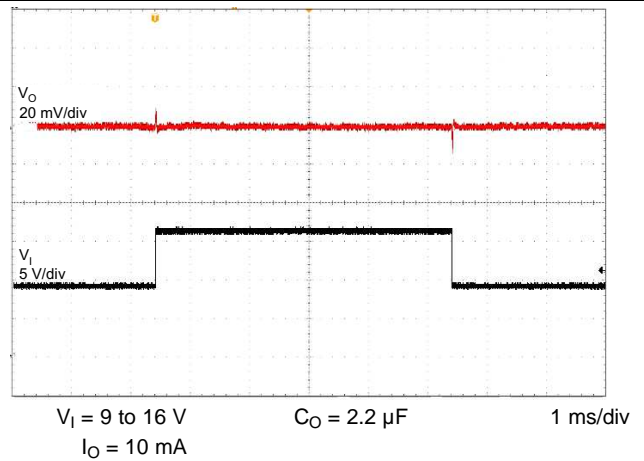

Figure 20. Line Transient ($V_O = 3.3\text{ V}$)

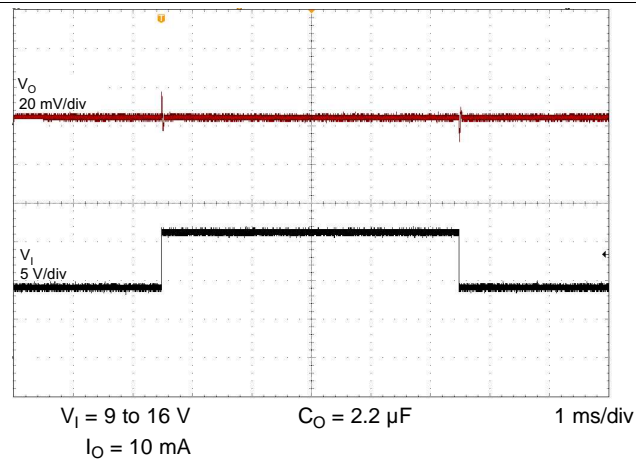

Figure 21. Line Transient ($V_O = 2.5\text{ V}$)

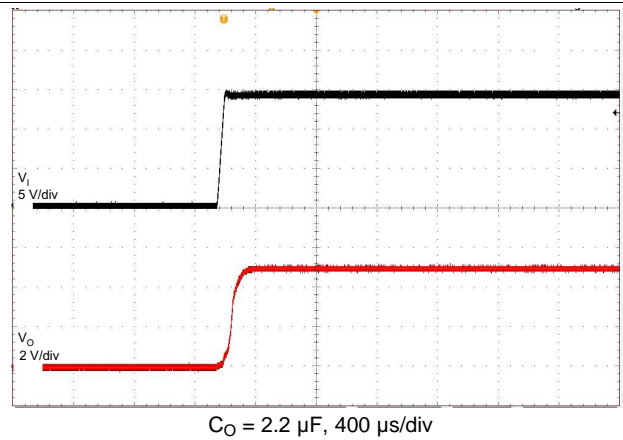

Figure 22. 5-V Power Up

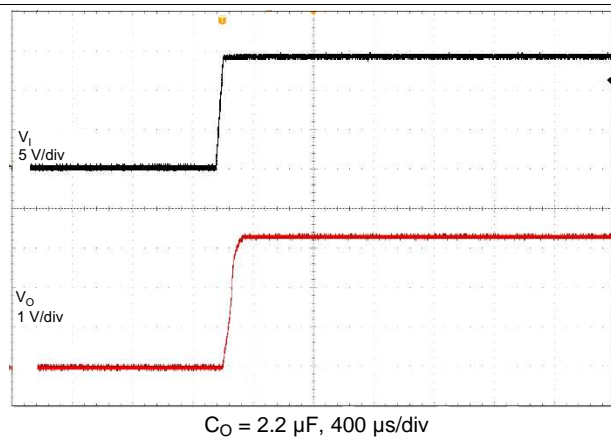

Figure 23. 3.3-V Power Up

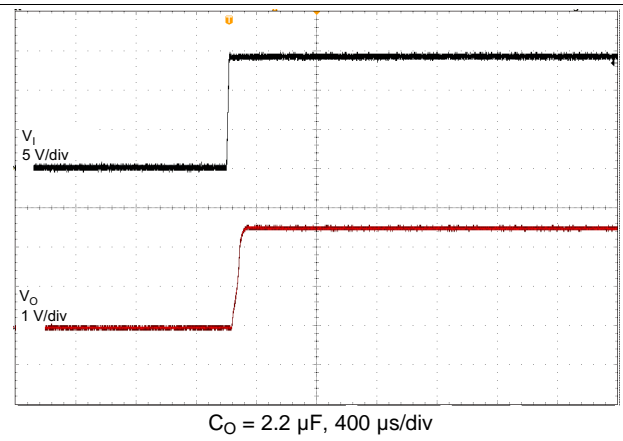

Figure 24. 2.5-V Power Up

8 Detailed Description

8.1 Overview

The TPS7B69xx-Q1 high-voltage linear regulator operates over a 4-V to 40-V input voltage range. The device has an output current capability of 150 mA and offers fixed output voltages of 2.5 V (TPS7B6925-Q1), 3.3 V (TPS7B6933-Q1) or 5 V (TPS7B6950-Q1). The device features a thermal shutdown and short-circuit protection to prevent damage during over-temperature and overcurrent conditions.

8.2 Functional Block Diagram

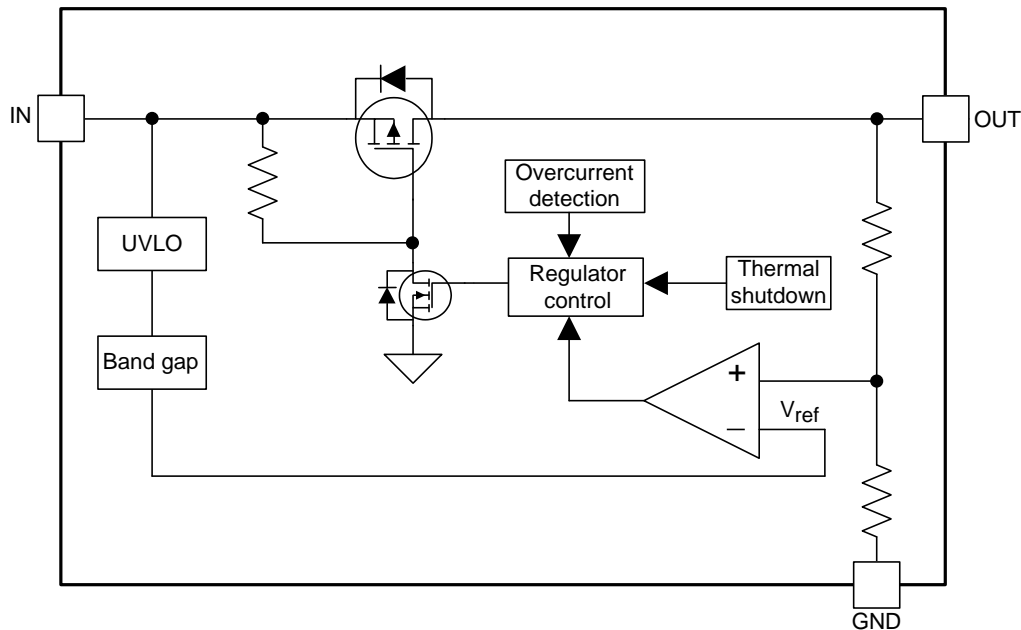

8.3 Feature Description

8.3.1 Input (IN)

The IN pin is a high-voltage-tolerant pin. A capacitor with a value higher than 0.1 μF is recommended to be connected close to this pin to better the transient performance.

8.3.2 Output (OUT)

The OUT pin is the regulated output based on the required voltage. The output has current limitation. During the initial power up, the regulator has a soft start incorporated to control the initial current through the pass element and the output capacitor.

In the event that the regulator drops out of regulation, the output tracks the input minus a drop based on the load current. When the input voltage drops below the UVLO threshold, the regulator shuts down until the input voltage recovers above the minimum startup level.

8.3.3 Output Capacitor Selection

For stable operation over the full temperature range and with load currents up to 150 mA, use a capacitor with an effective value between 2.2 μF and 100 μF and ESR smaller than 2 Ω . To better the load transient performance, an output capacitor, such as a ceramic capacitor with low ESR, is recommended.

8.3.4 Low-Voltage Tracking

At low input voltages, the regulator drops out of regulation and the output voltage tracks input minus a voltage based on the load current (I_L) and switch resistor. This tracking allows for a smaller input capacitor and can possibly eliminate the need for a boost converter during cold-crank conditions.

Feature Description (continued)

8.3.5 Thermal Shutdown

The TPS7B69xx-Q1 family of devices incorporates a thermal-shutdown (TSD) circuit as a protection from overheating. For continuous normal operation, the junction temperature should not exceed the TSD trip point. If the junction temperature exceeds the TSD trip point, the output turns off. When the junction temperature falls below the TSD trip point minus the hysteresis of TSD, the output turns on again. This cycling limits the dissipation of the regulator, protecting it from damage as a result of overheating.

The purpose of the design of the internal protection circuitry of the TPS7B69xx-Q1 family of devices is for protection against overload conditions, not as a replacement for proper heat-sinking. Continuously running the TPS7B69xx-Q1 family of devices into thermal shutdown degrades device reliability.

8.4 Device Functional Modes

8.4.1 Operation With V_I Less Than 4 V

The TPS7B69xx-Q1 family of devices operates with input voltages above 4 V. The maximum UVLO voltage is 3 V and the device operates at an input voltage above 4 V. The device can also operate at lower input voltages; no minimum UVLO voltage is specified. At input voltages below the actual UVLO, the device shuts down.

8.4.2 Operation With V_I Greater Than 4 V

When V_I is greater than 4 V, if the input voltage is higher than V_O plus the dropout voltage, the output voltage is equal to the set value. Otherwise, the output voltage is equal to V_I minus the dropout voltage.

9 Application and Implementation

NOTE

Information in the following applications sections is not part of the TI component specification, and TI does not warrant its accuracy or completeness. TI's customers are responsible for determining suitability of components for their purposes. Customers should validate and test their design implementation to confirm system functionality.

9.1 Application Information

The TPS7B69xx-Q1 family of devices is a 150-mA low-dropout linear regulator designed for up to 40-V V_I operation with only 15- μ A quiescent current at light loads. Use the PSpice transient model to evaluate the base function of the device. To download the PSpice transient model, go to the device product folder on www.TI.com. In addition to this model, specific evaluation modules (EVM) are available for these devices. For the EVM and the EVM user guide, go to the device product folder.

9.2 Typical Application

Figure 25 shows the typical application circuit for the TPS7B69xx-Q1 family of devices. Based on the end-application, different values of external components can be used. An application can require a larger output capacitor during fast load steps to achieve better load transient response. TI recommends a low-ESR ceramic capacitor with a dielectric of type X5R or X7R for better load transient response.

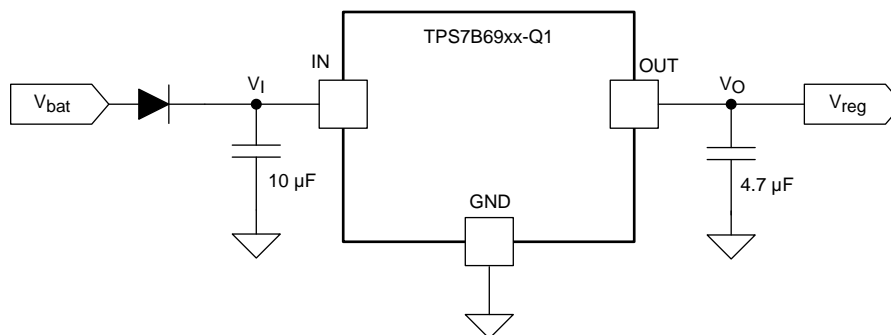

Figure 25. Typical Application Schematic for TPS7B69xx-Q1

9.2.1 Design Requirements

For this design example, use the parameters listed in [Table 1](#).

Table 1. Design Parameters

DESIGN PARAMETER	EXAMPLE VALUES
Input voltage range	4 to 40 V
Output voltage	2.5 V, 3.3 V, 5 V
Output current rating	150 mA
Output capacitor range	2.2 to 100 μ F
Output capacitor ESR range	1 m Ω to 2 Ω

9.2.2 Detailed Design Procedure

To begin the design process, determine the following:

- Input voltage range
- Output Voltage
- Output current rating

9.2.2.1 Input Capacitor

The device requires an input decoupling capacitor, the value of which depends on the application. The typical recommend value for the decoupling capacitor is higher than 0.1 μF . The voltage rating must be greater than the maximum input voltage.

9.2.2.2 Output Capacitor

The device requires an output capacitor to stabilize the output voltage. The output capacitor value should be between 2.2 μF and 100 μF . The ESR value range should be between 1 m Ω and 2 Ω . TI recommends a ceramic capacitor with low ESR to improve the load transient response.

9.2.2.3 Power Dissipation and Thermal Considerations

Use Equation 1 to calculate the power dissipated in the device.

$$P_D = I_O \times (V_I - V_O) + I_Q \times V_I$$

where

- P_D = continuous power dissipation
 - I_O = output current
 - V_I = input voltage
 - V_O = output voltage
- (1)

Because $I_Q \ll I_O$, the term $I_Q \times V_I$ in Equation 1 can be ignored.

For a device under operation at a given ambient air temperature (T_A), use Equation 2 to calculate the junction temperature (T_J).

$$T_J = T_A + (Z_{\theta JA} \times P_D)$$

where

- $Z_{\theta JA}$ = junction-to-ambient air thermal impedance
- (2)

Use Equation 3 to calculate the rise in junction temperature because of power dissipation.

$$\Delta T = T_J - T_A = (Z_{\theta JA} \times P_D)$$

(3)

For a given maximum junction temperature (T_{Jmax}), use Equation 4 to calculate the maximum ambient air temperature (T_{Amax}) at which the device can operate.

$$T_{Amax} = T_{Jmax} - (Z_{\theta JA} \times P_D)$$

(4)

9.2.3 Application Curve

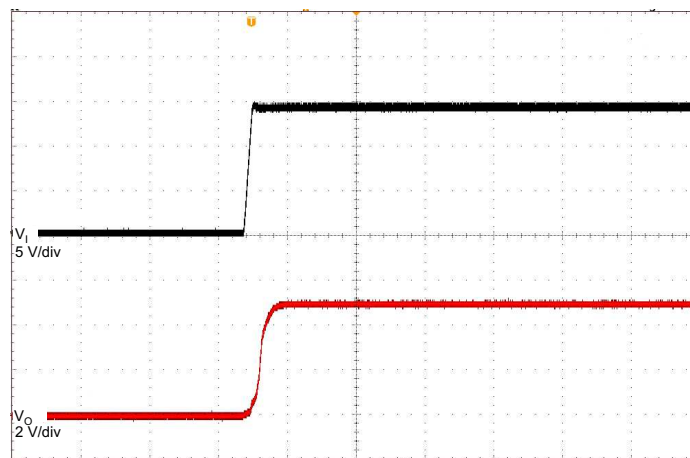

$C_O = 2.2 \mu\text{F}, 400 \mu\text{s/div}$

Figure 26. Power Up (5 V)

10 Power Supply Recommendations

The device is designed to operate from an input-voltage supply range between 4 V and 40 V. This input supply must be well regulated. If the input supply is located more than a few inches from the TPS7B69xx-Q1 device, TI recommends adding an electrolytic capacitor with a value of 10 μF and a ceramic bypass capacitor at the input.

11 Layout

11.1 Layout Guidelines

For the layout of TPS7B69xx-Q1 family of devices, place the input and output capacitors close to the devices as shown in [Figure 27](#) and [Figure 28](#). To enhance the thermal performance, TI recommends surrounding the device with some vias.

Minimize equivalent series inductance (ESL) and ESR to maximize performance and ensure stability. Place every capacitor as close as possible to the device and on the same side of the PCB as the regulator.

Do not place any of the capacitors on the opposite side of the PCB from where the regulator is installed. TI strongly discourages the use of long traces because they can impact system performance negatively and even cause instability.

If possible, and to ensure the maximum performance specified in this product data sheet, use the same layout pattern used for the TPS7B69xx-Q1 evaluation board.

11.2 Layout Example

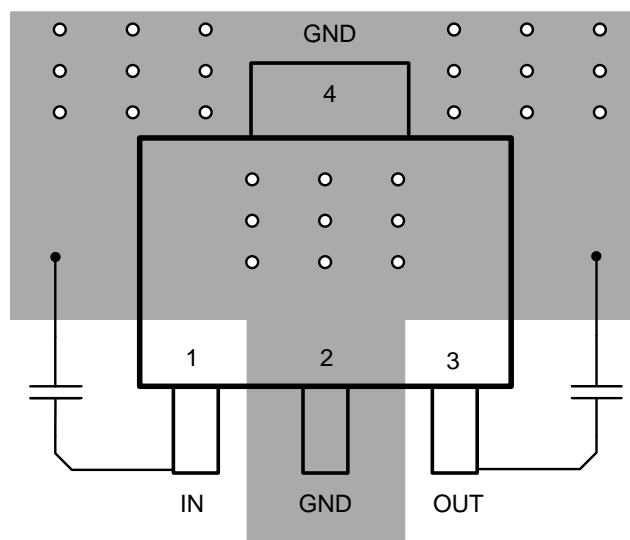

Figure 27. Layout Example for SOT-223 Package

Layout Example (continued)

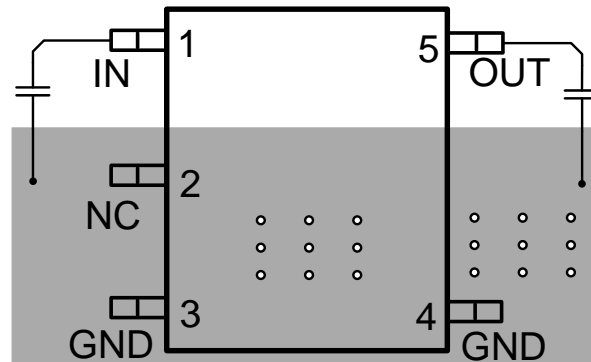

Figure 28. Layout Example for SOT-23 Package

12 Device and Documentation Support

12.1 Documentation Support

12.1.1 Related Documentation

For related documentation see the following:

TPS7B6950EVM User's Guide, [SLVUAC0](#).

12.2 Related Links

The table below lists quick access links. Categories include technical documents, support and community resources, tools and software, and quick access to sample or buy.

Table 2. Related Links

PARTS	PRODUCT FOLDER	SAMPLE & BUY	TECHNICAL DOCUMENTS	TOOLS & SOFTWARE	SUPPORT & COMMUNITY
TPS7B6925-Q1	Click here	Click here	Click here	Click here	Click here
TPS7B6933-Q1	Click here	Click here	Click here	Click here	Click here
TPS7B6950-Q1	Click here	Click here	Click here	Click here	Click here

12.3 Trademarks

All trademarks are the property of their respective owners.

12.4 Electrostatic Discharge Caution



These devices have limited built-in ESD protection. The leads should be shorted together or the device placed in conductive foam during storage or handling to prevent electrostatic damage to the MOS gates.

12.5 Glossary

[SLYZ022](#) — *TI Glossary*.

This glossary lists and explains terms, acronyms, and definitions.

13 Mechanical, Packaging, and Orderable Information

The following pages include mechanical, packaging, and orderable information. This information is the most current data available for the designated devices. This data is subject to change without notice and revision of this document. For browser-based versions of this data sheet, refer to the left-hand navigation.

PACKAGING INFORMATION

Orderable Device	Status (1)	Package Type	Package Drawing	Pins	Package Qty	Eco Plan (2)	Lead/Ball Finish (6)	MSL Peak Temp (3)	Op Temp (°C)	Device Marking (4/5)	Samples
TPS7B6925QDBVRQ1	ACTIVE	SOT-23	DBV	5	3000	Green (RoHS & no Sb/Br)	CU SN	Level-2-260C-1 YEAR	-40 to 125	ZBE2	Samples
TPS7B6925QDCYRQ1	ACTIVE	SOT-223	DCY	4	2500	Green (RoHS & no Sb/Br)	CU SN	Level-3-260C-168 HR	-40 to 125	7B6925	Samples
TPS7B6933QDBVRQ1	ACTIVE	SOT-23	DBV	5	3000	Green (RoHS & no Sb/Br)	CU SN	Level-2-260C-1 YEAR	-40 to 125	ZBF2	Samples
TPS7B6933QDCYRQ1	ACTIVE	SOT-223	DCY	4	2500	Green (RoHS & no Sb/Br)	CU SN	Level-3-260C-168 HR	-40 to 125	7B6933	Samples
TPS7B6950QDBVRQ1	ACTIVE	SOT-23	DBV	5	3000	Green (RoHS & no Sb/Br)	CU SN	Level-2-260C-1 YEAR	-40 to 125	ZAZ2	Samples
TPS7B6950QDCYRQ1	ACTIVE	SOT-223	DCY	4	2500	Green (RoHS & no Sb/Br)	CU SN	Level-3-260C-168 HR	-40 to 125	7B6950	Samples

(1) The marketing status values are defined as follows:

ACTIVE: Product device recommended for new designs.

LIFEBUY: TI has announced that the device will be discontinued, and a lifetime-buy period is in effect.

NRND: Not recommended for new designs. Device is in production to support existing customers, but TI does not recommend using this part in a new design.

PREVIEW: Device has been announced but is not in production. Samples may or may not be available.

OBSOLETE: TI has discontinued the production of the device.

(2) **RoHS:** TI defines "RoHS" to mean semiconductor products that are compliant with the current EU RoHS requirements for all 10 RoHS substances, including the requirement that RoHS substance do not exceed 0.1% by weight in homogeneous materials. Where designed to be soldered at high temperatures, "RoHS" products are suitable for use in specified lead-free processes. TI may reference these types of products as "Pb-Free".

RoHS Exempt: TI defines "RoHS Exempt" to mean products that contain lead but are compliant with EU RoHS pursuant to a specific EU RoHS exemption.

Green: TI defines "Green" to mean the content of Chlorine (Cl) and Bromine (Br) based flame retardants meet JS709B low halogen requirements of <=1000ppm threshold. Antimony trioxide based flame retardants must also meet the <=1000ppm threshold requirement.

(3) MSL, Peak Temp. - The Moisture Sensitivity Level rating according to the JEDEC industry standard classifications, and peak solder temperature.

(4) There may be additional marking, which relates to the logo, the lot trace code information, or the environmental category on the device.

(5) Multiple Device Markings will be inside parentheses. Only one Device Marking contained in parentheses and separated by a "~" will appear on a device. If a line is indented then it is a continuation of the previous line and the two combined represent the entire Device Marking for that device.

⁽⁶⁾ Lead/Ball Finish - Orderable Devices may have multiple material finish options. Finish options are separated by a vertical ruled line. Lead/Ball Finish values may wrap to two lines if the finish value exceeds the maximum column width.

Important Information and Disclaimer:The information provided on this page represents TI's knowledge and belief as of the date that it is provided. TI bases its knowledge and belief on information provided by third parties, and makes no representation or warranty as to the accuracy of such information. Efforts are underway to better integrate information from third parties. TI has taken and continues to take reasonable steps to provide representative and accurate information but may not have conducted destructive testing or chemical analysis on incoming materials and chemicals. TI and TI suppliers consider certain information to be proprietary, and thus CAS numbers and other limited information may not be available for release.

In no event shall TI's liability arising out of such information exceed the total purchase price of the TI part(s) at issue in this document sold by TI to Customer on an annual basis.

OTHER QUALIFIED VERSIONS OF TPS7B69-Q1 :

- Catalog: [TPS7B69](#)

NOTE: Qualified Version Definitions:

- Catalog - TI's standard catalog product

TAPE AND REEL INFORMATION



QUADRANT ASSIGNMENTS FOR PIN 1 ORIENTATION IN TAPE



*All dimensions are nominal

Device	Package Type	Package Drawing	Pins	SPQ	Reel Diameter (mm)	Reel Width W1 (mm)	A0 (mm)	B0 (mm)	K0 (mm)	P1 (mm)	W (mm)	Pin1 Quadrant
TPS7B6925QDBVRQ1	SOT-23	DBV	5	3000	178.0	9.0	3.3	3.2	1.4	4.0	8.0	Q3
TPS7B6925QDCYRQ1	SOT-223	DCY	4	2500	330.0	12.4	7.05	7.4	1.9	8.0	12.0	Q3
TPS7B6933QDBVRQ1	SOT-23	DBV	5	3000	178.0	9.0	3.3	3.2	1.4	4.0	8.0	Q3
TPS7B6933QDCYRQ1	SOT-223	DCY	4	2500	330.0	12.4	7.05	7.4	1.9	8.0	12.0	Q3
TPS7B6950QDBVRQ1	SOT-23	DBV	5	3000	178.0	9.0	3.3	3.2	1.4	4.0	8.0	Q3
TPS7B6950QDCYRQ1	SOT-223	DCY	4	2500	330.0	12.4	7.05	7.4	1.9	8.0	12.0	Q3

TAPE AND REEL BOX DIMENSIONS

*All dimensions are nominal

Device	Package Type	Package Drawing	Pins	SPQ	Length (mm)	Width (mm)	Height (mm)
TPS7B6925QDBVRQ1	SOT-23	DBV	5	3000	190.0	190.0	30.0
TPS7B6925QDCYRQ1	SOT-223	DCY	4	2500	340.0	340.0	38.0
TPS7B6933QDBVRQ1	SOT-23	DBV	5	3000	190.0	190.0	30.0
TPS7B6933QDCYRQ1	SOT-223	DCY	4	2500	340.0	340.0	38.0
TPS7B6950QDBVRQ1	SOT-23	DBV	5	3000	180.0	180.0	18.0
TPS7B6950QDCYRQ1	SOT-223	DCY	4	2500	340.0	340.0	38.0

DCY (R-PDSO-G4)

PLASTIC SMALL-OUTLINE

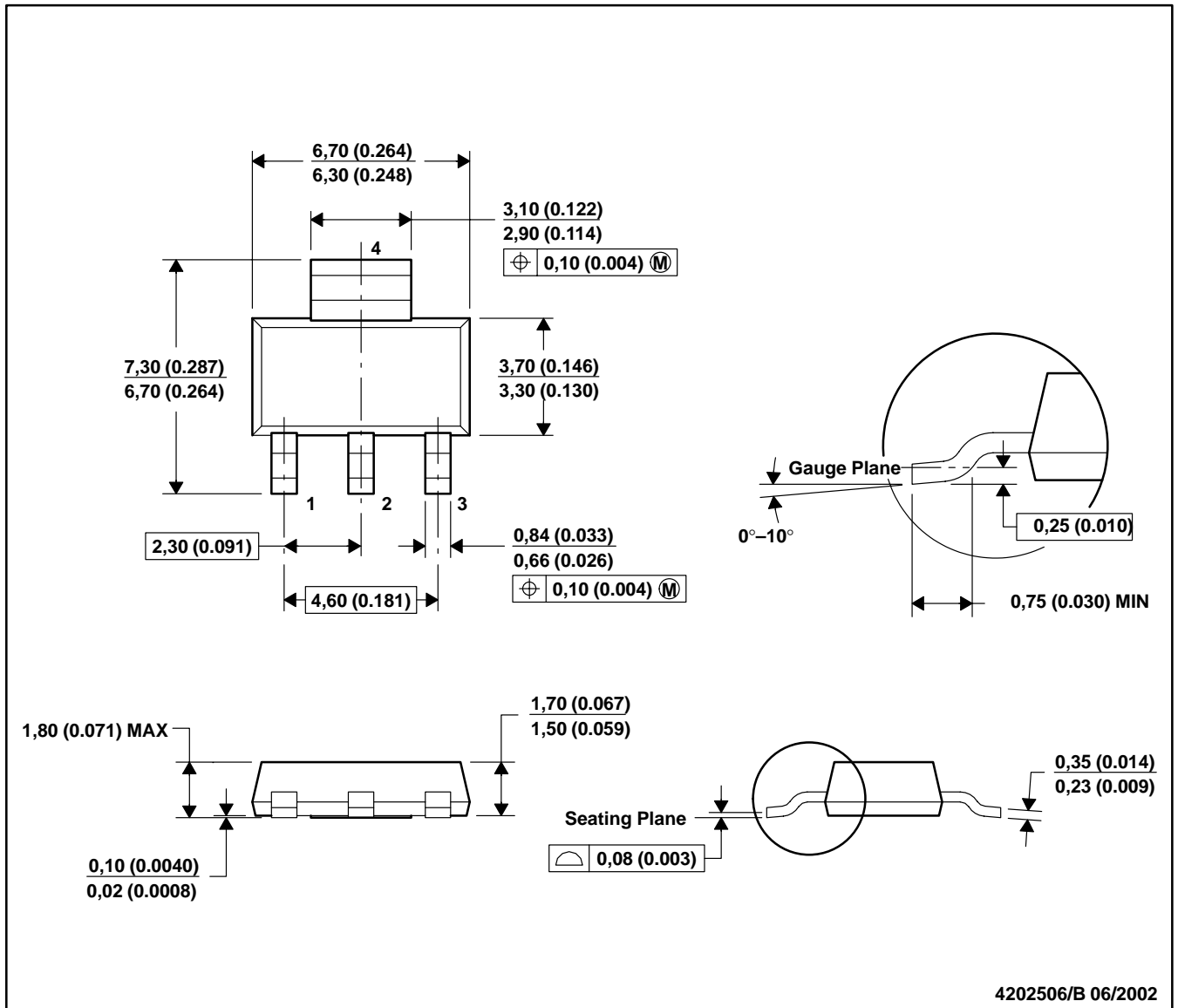

4202506/B 06/2002

- NOTES: A. All linear dimensions are in millimeters (inches).
 B. This drawing is subject to change without notice.
 C. Body dimensions do not include mold flash or protrusion.
 D. Falls within JEDEC TO-261 Variation AA.

DCY (R-PDSO-G4)

PLASTIC SMALL OUTLINE

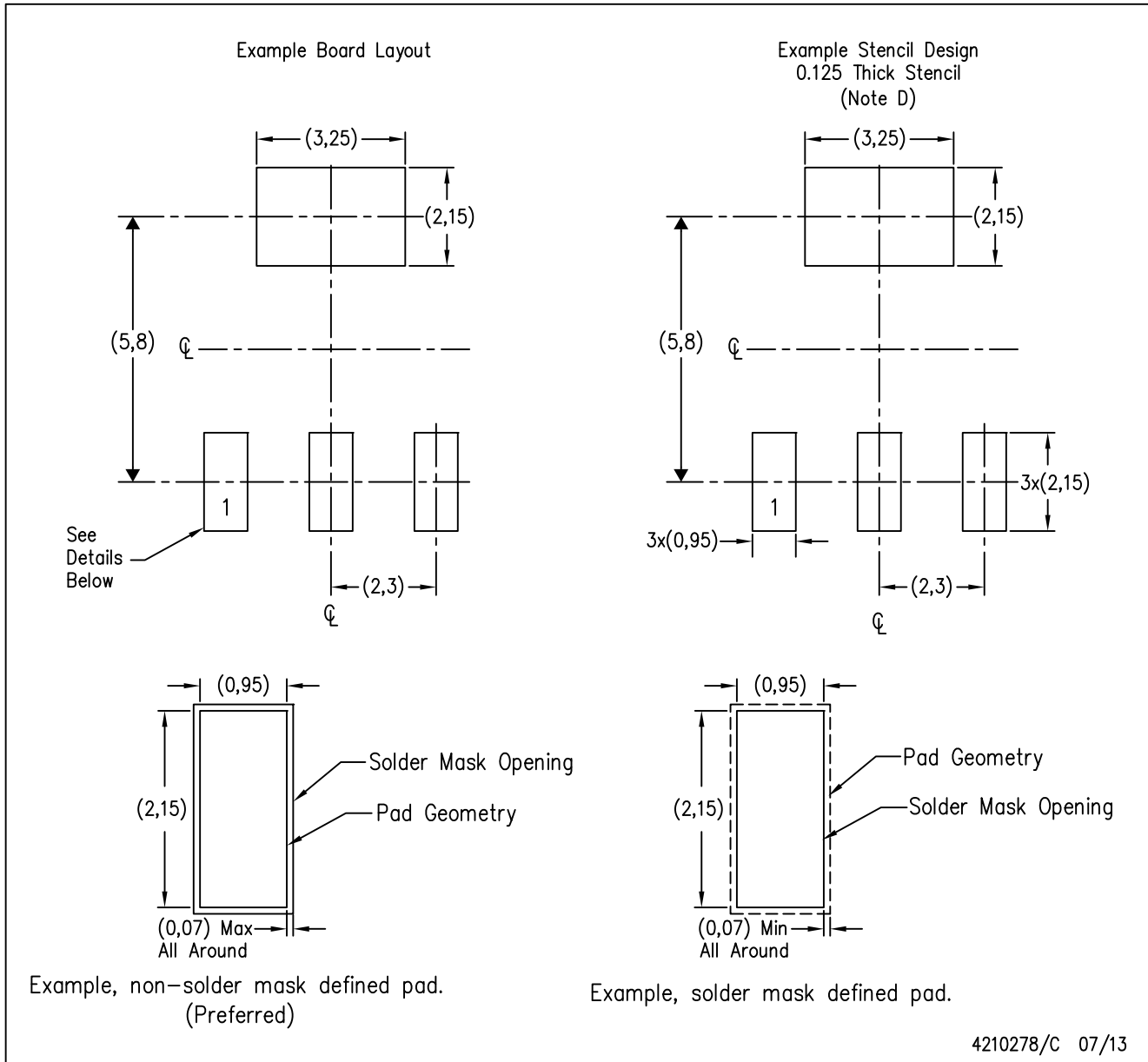

- NOTES:
- A. All linear dimensions are in millimeters.
 - B. This drawing is subject to change without notice.
 - C. Publication IPC-7351 is recommended for alternate designs.
 - D. Laser cutting apertures with trapezoidal walls and also rounding corners will offer better paste release. Customers should contact their board assembly site for stencil recommendations. Refer to IPC 7525 for stencil design considerations.

DBV (R-PDSO-G5)

PLASTIC SMALL-OUTLINE PACKAGE



- NOTES:
- A. All linear dimensions are in millimeters.
 - B. This drawing is subject to change without notice.
 - C. Body dimensions do not include mold flash or protrusion. Mold flash and protrusion shall not exceed 0.15 per side.
 - D. Falls within JEDEC MO-178 Variation AA.

DBV (R-PDSO-G5)

PLASTIC SMALL OUTLINE



- NOTES:
- A. All linear dimensions are in millimeters.
 - B. This drawing is subject to change without notice.
 - C. Customers should place a note on the circuit board fabrication drawing not to alter the center solder mask defined pad.
 - D. Publication IPC-7351 is recommended for alternate designs.
 - E. Laser cutting apertures with trapezoidal walls and also rounding corners will offer better paste release. Customers should contact their board assembly site for stencil design recommendations. Example stencil design based on a 50% volumetric metal load solder paste. Refer to IPC-7525 for other stencil recommendations.

IMPORTANT NOTICE

Texas Instruments Incorporated (TI) reserves the right to make corrections, enhancements, improvements and other changes to its semiconductor products and services per JESD46, latest issue, and to discontinue any product or service per JESD48, latest issue. Buyers should obtain the latest relevant information before placing orders and should verify that such information is current and complete.

TI's published terms of sale for semiconductor products (<http://www.ti.com/sc/docs/stdterms.htm>) apply to the sale of packaged integrated circuit products that TI has qualified and released to market. Additional terms may apply to the use or sale of other types of TI products and services.

Reproduction of significant portions of TI information in TI data sheets is permissible only if reproduction is without alteration and is accompanied by all associated warranties, conditions, limitations, and notices. TI is not responsible or liable for such reproduced documentation. Information of third parties may be subject to additional restrictions. Resale of TI products or services with statements different from or beyond the parameters stated by TI for that product or service voids all express and any implied warranties for the associated TI product or service and is an unfair and deceptive business practice. TI is not responsible or liable for any such statements.

Buyers and others who are developing systems that incorporate TI products (collectively, "Designers") understand and agree that Designers remain responsible for using their independent analysis, evaluation and judgment in designing their applications and that Designers have full and exclusive responsibility to assure the safety of Designers' applications and compliance of their applications (and of all TI products used in or for Designers' applications) with all applicable regulations, laws and other applicable requirements. Designer represents that, with respect to their applications, Designer has all the necessary expertise to create and implement safeguards that (1) anticipate dangerous consequences of failures, (2) monitor failures and their consequences, and (3) lessen the likelihood of failures that might cause harm and take appropriate actions. Designer agrees that prior to using or distributing any applications that include TI products, Designer will thoroughly test such applications and the functionality of such TI products as used in such applications.

TI's provision of technical, application or other design advice, quality characterization, reliability data or other services or information, including, but not limited to, reference designs and materials relating to evaluation modules, (collectively, "TI Resources") are intended to assist designers who are developing applications that incorporate TI products; by downloading, accessing or using TI Resources in any way, Designer (individually or, if Designer is acting on behalf of a company, Designer's company) agrees to use any particular TI Resource solely for this purpose and subject to the terms of this Notice.

TI's provision of TI Resources does not expand or otherwise alter TI's applicable published warranties or warranty disclaimers for TI products, and no additional obligations or liabilities arise from TI providing such TI Resources. TI reserves the right to make corrections, enhancements, improvements and other changes to its TI Resources. TI has not conducted any testing other than that specifically described in the published documentation for a particular TI Resource.

Designer is authorized to use, copy and modify any individual TI Resource only in connection with the development of applications that include the TI product(s) identified in such TI Resource. NO OTHER LICENSE, EXPRESS OR IMPLIED, BY ESTOPPEL OR OTHERWISE TO ANY OTHER TI INTELLECTUAL PROPERTY RIGHT, AND NO LICENSE TO ANY TECHNOLOGY OR INTELLECTUAL PROPERTY RIGHT OF TI OR ANY THIRD PARTY IS GRANTED HEREIN, including but not limited to any patent right, copyright, mask work right, or other intellectual property right relating to any combination, machine, or process in which TI products or services are used. Information regarding or referencing third-party products or services does not constitute a license to use such products or services, or a warranty or endorsement thereof. Use of TI Resources may require a license from a third party under the patents or other intellectual property of the third party, or a license from TI under the patents or other intellectual property of TI.

TI RESOURCES ARE PROVIDED "AS IS" AND WITH ALL FAULTS. TI DISCLAIMS ALL OTHER WARRANTIES OR REPRESENTATIONS, EXPRESS OR IMPLIED, REGARDING RESOURCES OR USE THEREOF, INCLUDING BUT NOT LIMITED TO ACCURACY OR COMPLETENESS, TITLE, ANY EPIDEMIC FAILURE WARRANTY AND ANY IMPLIED WARRANTIES OF MERCHANTABILITY, FITNESS FOR A PARTICULAR PURPOSE, AND NON-INFRINGEMENT OF ANY THIRD PARTY INTELLECTUAL PROPERTY RIGHTS. TI SHALL NOT BE LIABLE FOR AND SHALL NOT DEFEND OR INDEMNIFY DESIGNER AGAINST ANY CLAIM, INCLUDING BUT NOT LIMITED TO ANY INFRINGEMENT CLAIM THAT RELATES TO OR IS BASED ON ANY COMBINATION OF PRODUCTS EVEN IF DESCRIBED IN TI RESOURCES OR OTHERWISE. IN NO EVENT SHALL TI BE LIABLE FOR ANY ACTUAL, DIRECT, SPECIAL, COLLATERAL, INDIRECT, PUNITIVE, INCIDENTAL, CONSEQUENTIAL OR EXEMPLARY DAMAGES IN CONNECTION WITH OR ARISING OUT OF TI RESOURCES OR USE THEREOF, AND REGARDLESS OF WHETHER TI HAS BEEN ADVISED OF THE POSSIBILITY OF SUCH DAMAGES.

Unless TI has explicitly designated an individual product as meeting the requirements of a particular industry standard (e.g., ISO/TS 16949 and ISO 26262), TI is not responsible for any failure to meet such industry standard requirements.

Where TI specifically promotes products as facilitating functional safety or as compliant with industry functional safety standards, such products are intended to help enable customers to design and create their own applications that meet applicable functional safety standards and requirements. Using products in an application does not by itself establish any safety features in the application. Designers must ensure compliance with safety-related requirements and standards applicable to their applications. Designer may not use any TI products in life-critical medical equipment unless authorized officers of the parties have executed a special contract specifically governing such use. Life-critical medical equipment is medical equipment where failure of such equipment would cause serious bodily injury or death (e.g., life support, pacemakers, defibrillators, heart pumps, neurostimulators, and implantables). Such equipment includes, without limitation, all medical devices identified by the U.S. Food and Drug Administration as Class III devices and equivalent classifications outside the U.S.

TI may expressly designate certain products as completing a particular qualification (e.g., Q100, Military Grade, or Enhanced Product). Designers agree that it has the necessary expertise to select the product with the appropriate qualification designation for their applications and that proper product selection is at Designers' own risk. Designers are solely responsible for compliance with all legal and regulatory requirements in connection with such selection.

Designer will fully indemnify TI and its representatives against any damages, costs, losses, and/or liabilities arising out of Designer's non-compliance with the terms and provisions of this Notice.