

产品规格承认书

SPECIFICATION FOR APPROVAL

一体成型功率电感

Unibody Inductor

客户产品名称（材料）：

Customer Part Number

合泰盟方产品名称（材料）：

MCF-1050-3R3-N2

Hotland Part Number

内 容

CONTENT

1.1 特性曲线	Product characteristic curve
2.1 外形和尺寸要求	Shape and Dimensions and Appearance Requirement
2.1 电磁和机械特性	Electromagnetic and Mechanical Property
3 包 装	Dimensions and peel force of top cover tape
4 验收规则	Inspection Rules
5 说 明	Note

客户名称：

CUSTOMER

确 认：

APPROVED

拟制 Drawn	曾素梅	审核 Check	蒋建城	批准 Approved	Gao Ruby	日期 Date	2018-03-05
-------------	-----	-------------	-----	----------------	----------	------------	------------

1. Product characteristic curve:

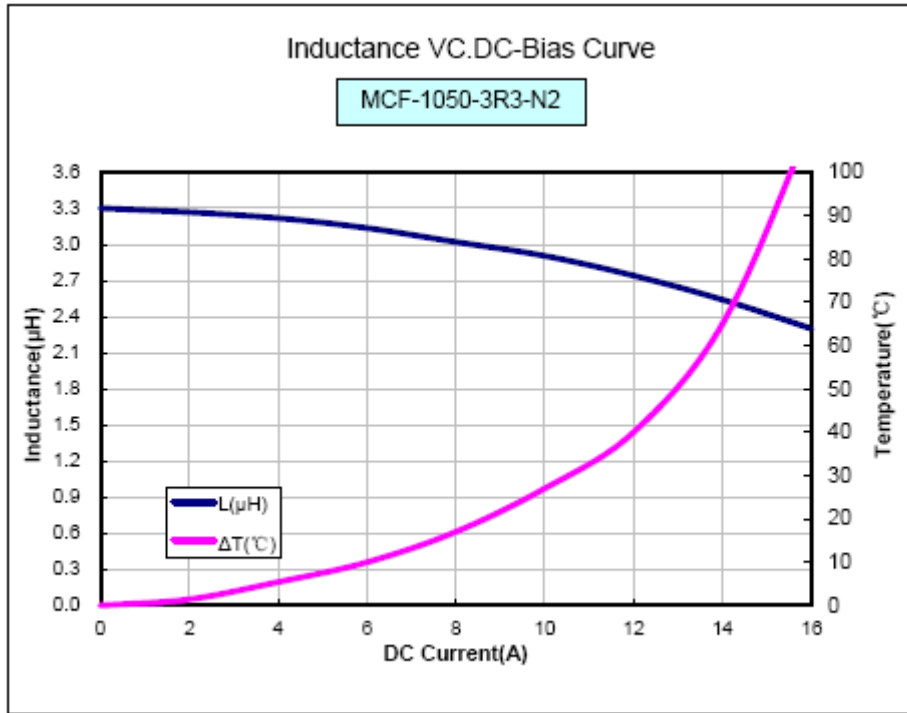

2. Shape and Dimensions and Appearance Requirement, Electromagnetic and Mechanical Property.

Product Presentation



Power Choke Coil MCF-1050-3R3-N2 Type

※ Features

High performance (Isat) realized by metal dust core.
 Low profile: Thickness max. 5.0mm;
 Low loss and low resistance
 Capable of corresponding high frequency (1MHz)
 100% lead (Pb) free meet RoHS standards

※ Application

DC/DC converters for laptop motherboards/CPU
 Thin type of on-board power supply module for
 Voltage regulator VRM for server

※ Outline Dimensions

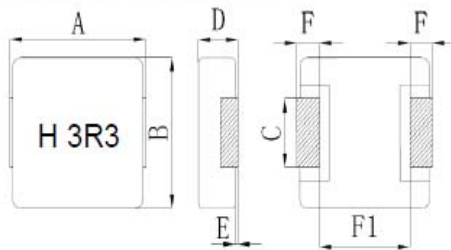

※ Recommend Land Pattern Dimensions

The customer shall determine the land dimensions shown above after confirming and safety.

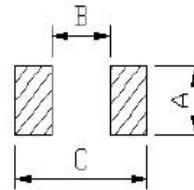

/	mm
A	4.1
B	5.4
C	13.6

Series	A(mm)	B(mm)	C(mm)	D(mm)	E(mm)	F(mm)	F1(mm)
MCF-1050-3R3-N2	11.5 Max.	10.0±0.3	3.0±0.5	5.0Max	0~+0.15	2.0±0.5	7.5±1.0

※ Specifications

Part Number	L0(uH) Inductance (uH) @ (0A) 100KHz,1.0V	Rdc (mΩ) @25°C		Heat Rating Current DC Amps. Idc (A)	Saturation Current DC Amps. Isat (A)
		Typical	Maximum		
MCF-1050-3R3-N2	3.3±20%	9.30	11.00	12.00	16.00

If you require another part number please contact with us.

※ Note

- All test data is reference to 25°C ambient.
- Idc: DC current (A) that will cause an approximate ΔT of 40°C
- Isat : DC current (A) that will cause L0 to drop approximately 30%Typ
- Operat between temperature range -55°C to +125°C
- The part temperature (ambient + temp rise) should not exceed 125°C under worst case operating conditions.
 Circuit design, component. PWB trace size and thickness, airflow and other cooling precision all affect the part temperature. Part temperature should be verified in the den application.
- The rated current as listed is either the saturation current or the heating current depending on which value is lower

3. Dimensions and peel force of top cover tape

Roll Dimensions

A (mm)	B (mm)	C (mm)	D (mm)	V (mm)	H (mm)	W1 (mm)
φ330.0	φ100.0	φ13.0	1.9	30.4	100.0	24.4
±1.5	±0.5	±0.2	±0.4		±0.5	+2.0 -0.0

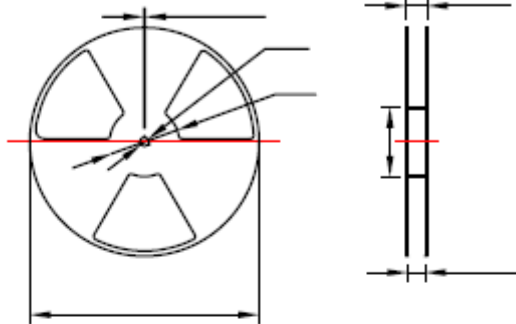

Peel Strength of Cover tape

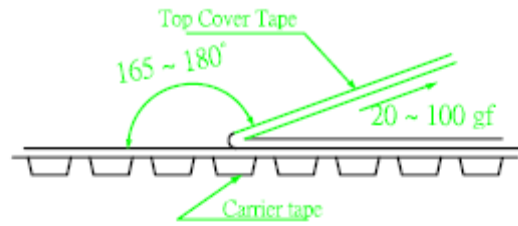

Peel Angel :165~180° form
The tape adhesive face.
Peel Velocity:300mm / minute
Peel Strength:20~100gf

Carrier Tape Dimensions:mm

W	A ₀	B ₀	K ₀	P	F	E	C ₀	C ₁	P ₀	P ₂	T
24.00 ^{+0.20} _{-0.20}	10.50 ^{+0.10} _{-0.10}	10.50 ^{+0.10} _{-0.10}	5.70 ^{+0.10} _{-0.10}	18.00 ^{+0.10} _{-0.10}	11.50 ^{+0.10} _{-0.10}	1.75 ^{+0.10} _{-0.10}	φ1.50 ^{+0.10} _{-0.10}	φ1.50 ^{+0.10} _{-0.10}	4.00 ^{+0.10} _{-0.10}	2.00 ^{+0.10} _{-0.10}	0.50 ^{+0.05} _{-0.05}

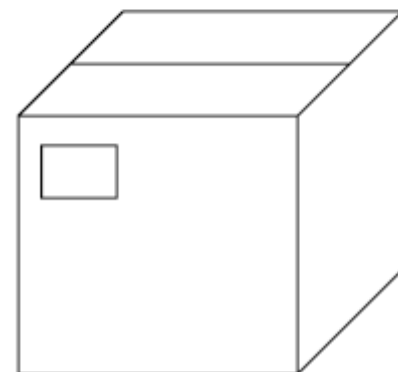
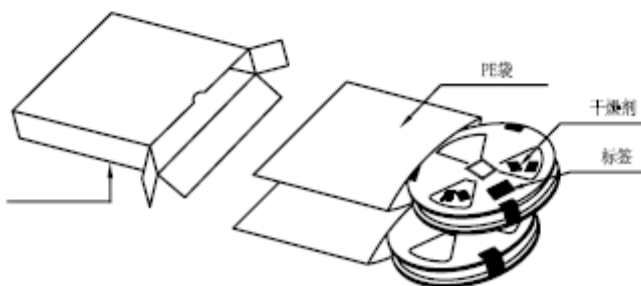
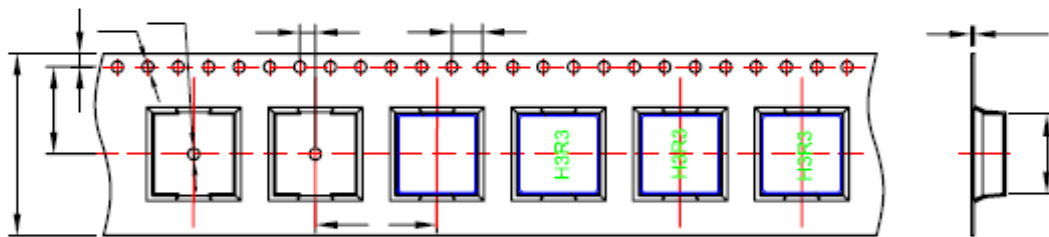

Quantity:
700 pcs /Roll
4200 pcs/Bundle

4. 验收规则

Inspection Rules

1 产品的验收按 GB/T2828.1-2003 规定进行,其检查水平: 外观、尺寸, II, AQL=0.4; L0A, L30DC, S-4, AQL=0.15; 绝缘电阻每批抽 10 只。

The inspection must be performed per GB/T2828.1-2003, with its examination level: Appearance and dimensions, II, AQL=0.4; L0A and L30DC, S-4, AQL: 0.15; Insulation resistance spot test 10 pieces every batch.

2 客户在接收到磁芯产品后一个月内须验收完毕,并将验收结果书面通知供货方,否则视为已验收合格。
Inspection will be completed and inspection result will be feedback to Hotland in written within one month after cores are received from Hotland or it will be considered approved by customer.

3 产品最佳有效使用期限 6 个月。

5. 说明

NOTE

1 在使用产品前,用户应自行确定本产品是否适用于自身设计,仅保证产品符合产品规格书要求。

Before using these products, buyer agrees to determine suitability of the product for their intended use of application. only ensure our products compliance to this specification.

2、本产品不得用于潮湿的环境,如水或其它相当液体中,因为在潮湿条件下,绝缘强度会很低。

This product must not be used in wet condition by water or equal because insulation strength becomes very low on the cognition.

3、电路设计、组件的放置、PCB 大小和厚度、气流及冷却设备都会影响部件温度,在最终应用时,需要对部件温度进行核对。

Circuit design, component placement, PCB trace size and thickness, airflow and other cooling provision all affect the part temperature. Part temperature should be verified in the end application.

4、本承认书的数据更改需经双方确认,任何一方单独修改无效。

Any revision to the specification Approval must be confirmed by both the supplier and the customer, otherwise the revision is invalid.

5、本承认书在客户收到 7 天之内,必须签章返回,逾期视为默认。

The specification Approval should be sent back to the supplier with customer's chop on it within 7 days after receiving it, or we will take it as approved by customer.

备注:所有中英文对照以中文为准,英文仅供参考。