

1. Description

This Power MOSFET is produced using KIA advanced planar stripe DMOS technology. This advanced has been especially tailored to minimize on-state resistance, provide superior switching performance, and withstand high energy pulse in the avalanche and commutation mode. These devices are well suited for high efficiency switched mode power supplies, active power factor correction based on half bridge topology.

2. Features

- n $R_{DS(on)}=0.85\Omega @ V_{GS}=10V$
- n Low gate charge (typical 63nC)
- n High ruggedness
- n Fast switching capability
- n Avalanche energy specified
- n Improved dv/dt capability
- n ESD improved capability

3. Pin configuration

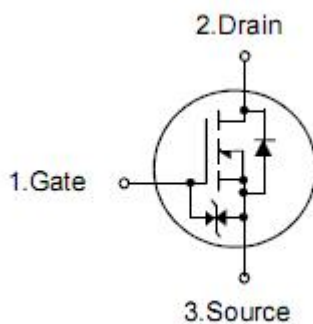
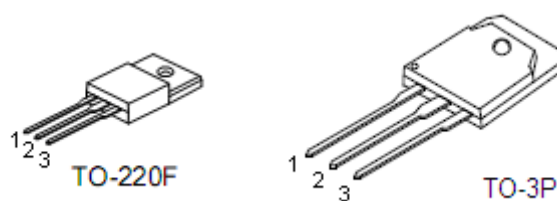

Pin	Function
1	Gate
2	Drain
3	Source

4. Absolute maximum ratings

(T_C= 25 °C , unless otherwise specified)

Parameter	Symbol	Ratings		Units	
		TO-220F	TO-3P		
Drain-source voltage	V _{DSS}	800		V	
Gate-source voltage	V _{GSS}	±25		V	
Drain current continuous	I _D	T _C =25°C	10*	10	A
		T _C =100°C	6 *	6	A
Drain current pulsed (note1)	I _{DP}	40		A	
Avalanche energy	Repetitive (note1)	E _{AR}		30.5	mJ
	Single pulse (note2)	E _{AS}		350	mJ
Peak diode recovery dv/dt (note 3)	dv/dt	4.5		V/ns	
Total power dissipation	P _D	T _C =25°C	42	305	W
		derate above 25°C	0.34	2.44	W/°C
Junction temperature	T _J	+150		°C	
Storage temperature	T _{STG}	-55~+150		°C	

* Drain current limited by maximum junction temperature.

5. Thermal characteristics

Parameter	Symbol	Ratings		Units
		TO-220F	TO-3P	
Thermal resistance,junction-ambient	R _{thJA}	62.5		°C/W
Thermal resistance,case-to-sink typ.	R _{thCS}	-		
Thermal resistance,Junction-case	R _{thJC}	2.95	0.4	

6. Electrical characteristics

(T_J=25°C, unless otherwise specified)

Parameter	Symbol	Conditions	Min	Typ	Max	Units
Off characteristics						
Drain-source breakdown voltage	BV _{DSS}	V _{GS} =0V, I _D =250μA	800	-	-	V
Zero gate voltage drain current	I _{DSS}	V _{DS} =800V, V _{GS} =0V	-	-	1	μA
		V _{DS} =640V, T _C =125 °C	-	-	10	μA
Gate-body leakage current	Forward	I _{GSS}	-	-	10	μA
	Reverse					
					-10	μA
Breakdown voltage temperature coefficient	ΔBV _{DSS} /ΔT _J	I _D =250μA	-	0.8	-	V/°C
On characteristics						
Gate threshold voltage	V _{GS(th)}	V _{DS} =V _{GS} , I _D =250μA	2.0	-	4.0	V
Static drain-source on-resistance	R _{DS(on)}	V _{DS} =10V, I _D =5A	-	0.85	1.1	Ω
Dynamic characteristics						
Input capacitance	C _{iss}	V _{DS} =25V, V _{GS} =0V, f=1MHz	-	2230	-	pF
Output capacitance	C _{oss}		-	135	-	pF
Reverse transfer capacitance	C _{rss}		-	74	-	pF
Switching characteristics						
Turn-on delay time	t _{d(on)}	V _{DD} =400V, I _D =10A, R _G =25Ω (note4,5)	-	25	-	ns
Rise time	t _r		-	35	-	ns
Turn-off delay time	t _{d(off)}		-	225	-	ns
Fall time	t _f		-	145	-	ns
Total gate charge	Q _g	V _{DS} =640V, I _D =10A, V _{GS} =10V (note4,5)	-	63	-	nC
Gate-source charge	Q _{gs}		-	10	-	nC
Gate-drain charge	Q _{gd}		-	25	-	nC
Drain-source diode characteristics						
Drain-source diode forward voltage	V _{SD}	V _{GS} =0V, I _D =10A	-	-	1.4	V
Continuous drain-source current	I _{SD}		-	-	9	A
Pulsed drain-source current	I _{SM}		-	-	36	A
Reverse recovery time	t _{rr}	I _{SD} =10A di _{SD} /dt=100A/μs (note4)	-	850	-	ns
Reverse recovery charge	Q _{rr}		-	10	-	μC

Note: 1 Repetitive rating: pulse width limited by maximum junction temperature

2. L=6.3mH, I_{AS}=10A, V_{DD}=50V, R_G=25Ω, starting T_J=25°C

3. I_{SD}≤9A, di/dt≤200A/μs, V_{DD}≤BV_{DSS}, starting T_J=25 °C

4. Pulse test: pulse width≤300μs, duty cycle≤2%

5. Essentially independent of operating temperature

7. Typical characteristics

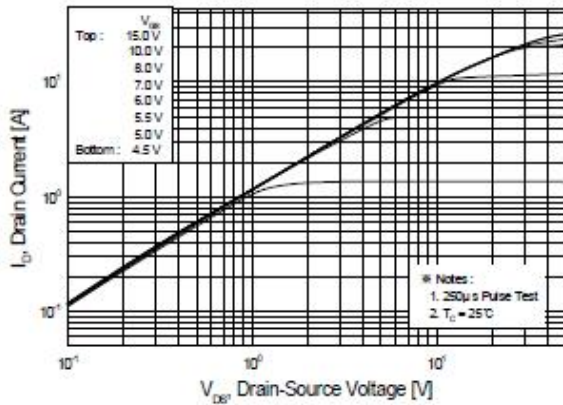

Figure 1. On-Region Characteristics

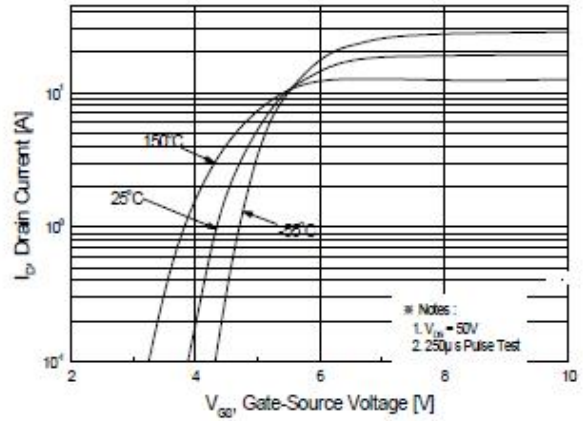

Figure 2. Transfer Characteristics

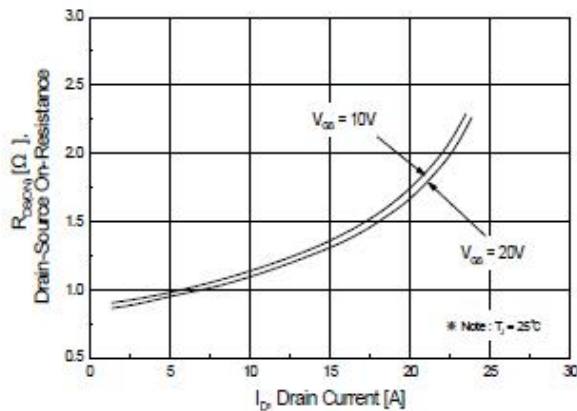

Figure 3. On-Resistance Variation vs Drain Current and Gate Voltage

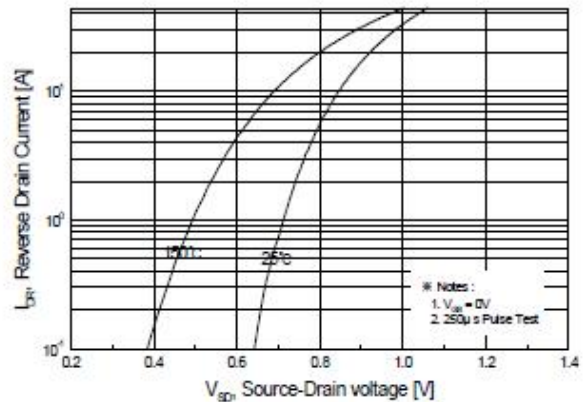

Figure 4. Body Diode Forward Voltage Variation with Source Current and Temperature

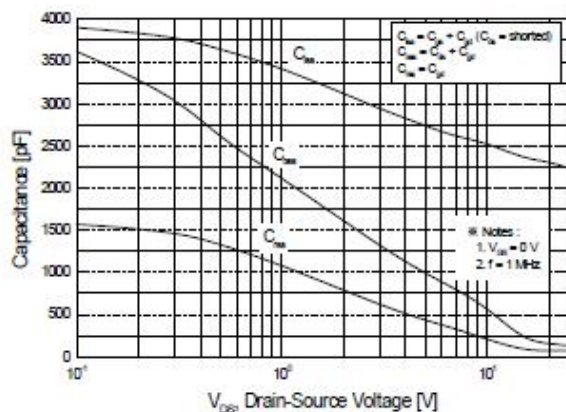

Figure 5. Capacitance Characteristics

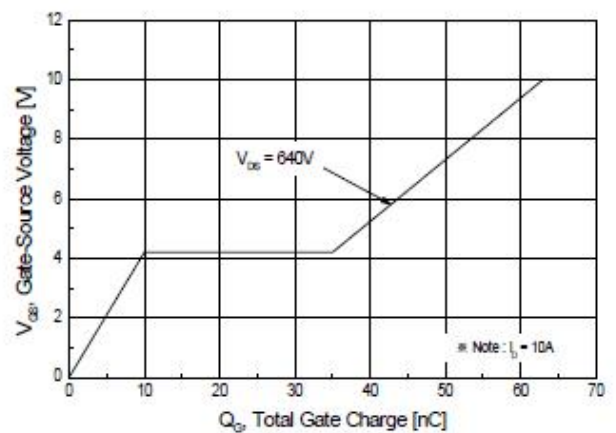

Figure 6. Gate Charge Characteristics

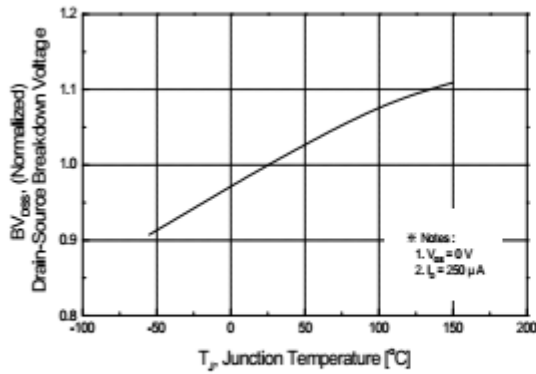

Figure 7. Breakdown Voltage Variation vs Temperature

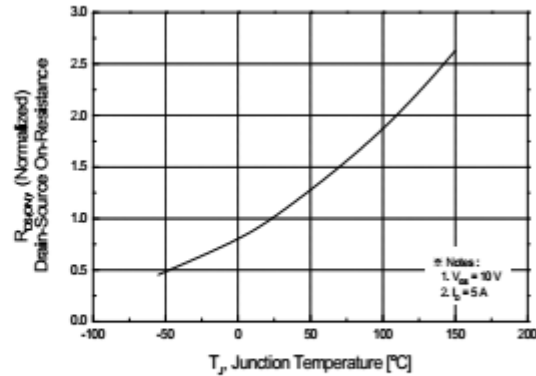

Figure 8. On-Resistance Variation vs Temperature

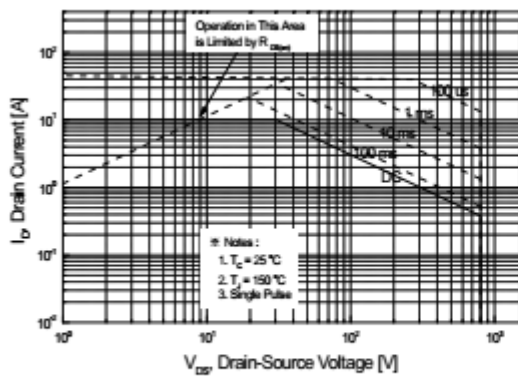

Figure 9. Maximum Safe Operating Area

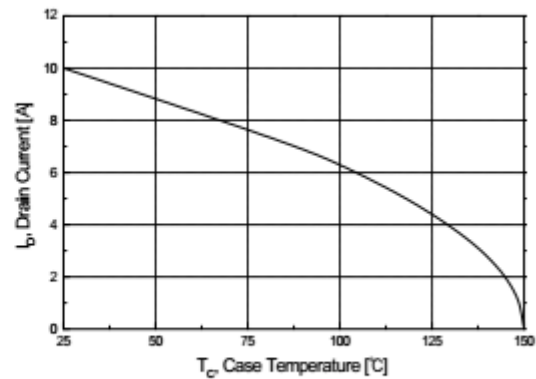

Figure 10. Maximum Drain Current vs Case Temperature

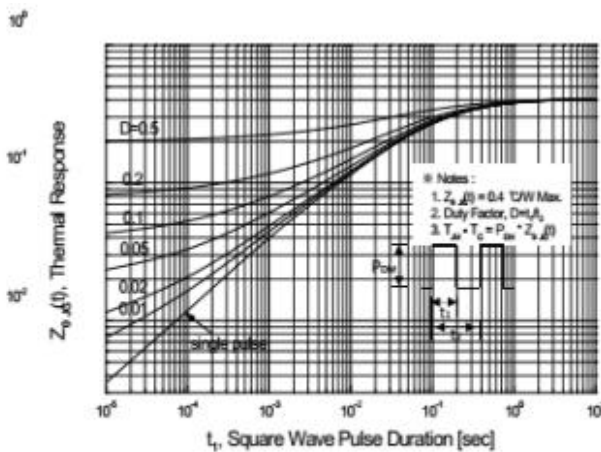

Figure 11-1. Transient Thermal Response Curve for TO-3P

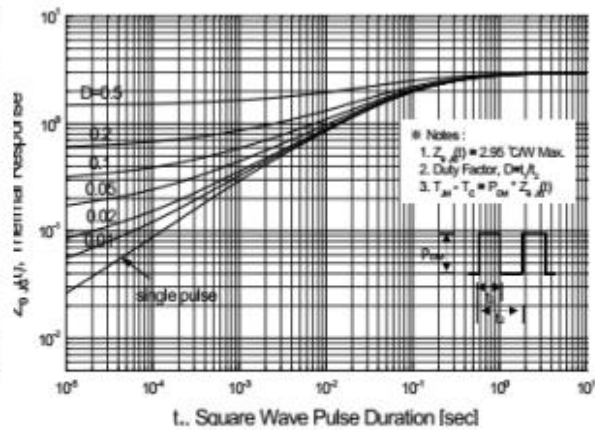

Figure 11-2. Transient Thermal Response Curve for TO-220F