



DESCRIPTION:

JST26Z provide high dv/dt rate with strong resistance to electromagnetic interference. With high commutation performances, 3 quadrants products especially recommended for use on inductive load.

JST26Z provide insulation voltage rated at 2500V RMS from all three terminals to external heatsink complying with UL standards (File ref: E252906).

MAIN FEATURES

Symbol	Value	Unit
$I_{T(RMS)}$	25	A
V_{DRM}/V_{RRM}	600 and 800 and 1200	V

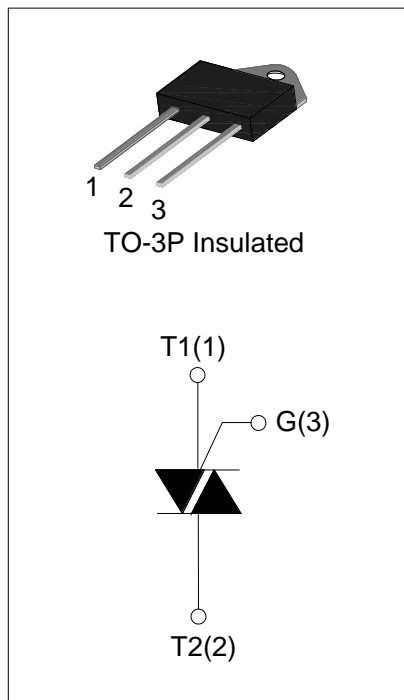

ABSOLUTE MAXIMUM RATINGS

Parameter		Symbol	Value	Unit
Storage junction temperature range		T_{stg}	-40-150	°C
Operating junction temperature range		T_j	-40-125	°C
Repetitive peak off-state voltage ($T_j=25^\circ\text{C}$)		V_{DRM}	600/800/1200	V
Repetitive peak reverse voltage ($T_j=25^\circ\text{C}$)		V_{RRM}	600/800/1200	V
Non repetitive surge peak Off-state voltage		V_{DSM}	$V_{DRM} + 100$	V
Non repetitive peak reverse voltage		V_{RSM}	$V_{RRM} + 100$	V
RMS on-state current	TO-3P(Ins) ($T_C=100^\circ\text{C}$)	$I_{T(RMS)}$	25	A
Non repetitive surge peak on-state current (full cycle, F=50Hz)		I_{TSM}	250	A
I^2t value for fusing ($t_p=10\text{ms}$)		I^2t	340	A^2s
Critical rate of rise of on-state current ($I_G=2 \times I_{GT}$)		di/dt	50	$\text{A}/\mu\text{s}$
Peak gate current		I_{GM}	4	A
Average gate power dissipation		$P_{G(AV)}$	1	W

Peak gate power	P_{GM}	10	W
-----------------	----------	----	---

ELECTRICAL CHARACTERISTICS ($T_j=25^\circ\text{C}$ unless otherwise specified)

 V_{DRM}/V_{RRM} : 600/800V

Symbol	Test Condition	Quadrant		JST26Z-600/800V		Unit
				BW	CW	
I_{GT}	$V_D=12V R_L=33\Omega$	I - II -III	MAX	50	35	mA
V_{GT}		I - II -III	MAX	1.3		V
V_{GD}	$V_D=V_{DRM} T_j=125^\circ\text{C}$ $R_L=3.3K\Omega$	I - II -III	MIN	0.2		V
I_L	$I_G=1.2I_{GT}$	I -III	MAX	80	70	mA
		II		100	80	
I_H	$I_T=100\text{mA}$		MAX	75	50	mA
dV/dt	$V_D=2/3V_{DRM}$ Gate Open $T_j=125^\circ\text{C}$		MIN	1000	500	V/ μs

 V_{DRM}/V_{RRM} : 1200V

Symbol	Test Condition	Quadrant		JST26Z-1200V		Unit
				BW	CW	
I_{GT}	$V_D=12V R_L=33\Omega$	I - II -III	MAX	50	35	mA
V_{GT}		I - II -III	MAX	1.5		V
V_{GD}	$V_D=V_{DRM} T_j=125^\circ\text{C}$ $R_L=3.3K\Omega$	I - II -III	MIN	0.2		V
I_L	$I_G=1.2I_{GT}$	I -III	MAX	90	70	mA
		II		100	80	
I_H	$I_T=100\text{mA}$		MAX	80	60	mA
dV/dt	$V_D=2/3V_{DRM}$ Gate Open $T_j=125^\circ\text{C}$		MIN	1500	1000	V/ μs

STATIC CHARACTERISTICS

Symbol	Parameter		Value(MAX)	Unit
V_{TM}	$I_{TM}=35A t_p=380\mu\text{s}$	$T_j=25^\circ\text{C}$	1.5	V
I_{DRM}	$V_D=V_{DRM} V_R=V_{RRM}$	$T_j=25^\circ\text{C}$	5	μA
I_{RRM}		$T_j=125^\circ\text{C}$	3	mA

THERMAL RESISTANCES

Symbol	Parameter		Value	Unit
$R_{th(j-c)}$	junction to case(AC)	TO-3P(Ins)	0.8	$^{\circ}C/W$

ORDERING INFORMATION

<p>J</p> <p>JieJie Microelectronics Co.,Ltd</p>	<p>ST</p> <p>Triacs</p> <p>$I_{T(RMS)}:25A$</p>	<p>26</p>	<p>Z</p> <p>Z:TO-3P(Ins)</p>	<p>-600</p> <p>600:$V_{DRM}/V_{RRM} \geq 600V$ 800:$V_{DRM}/V_{RRM} \geq 800V$ 1200:$V_{DRM}/V_{RRM} \geq 1200V$</p>	<p>BW</p> <p>BW:$I_{GT3} \leq 50mA$ CW:$I_{GT3} \leq 35mA$</p>
--	---	------------------	-------------------------------------	--	--

PACKAGE MECHANICAL DATA

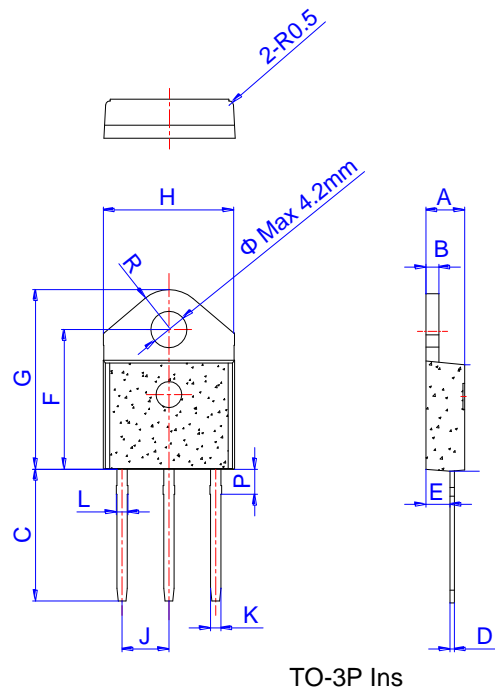

Ref.	Dimensions					
	Millimeters			Inches		
	Min.	Typ.	Max.	Min.	Typ.	Max.
A	4.40		4.60	0.173		0.181
B	1.45		1.55	0.057		0.061
C	14.35		15.60	0.565		0.614
D	0.50		0.70	0.020		0.028
E	2.70		2.90	0.106		0.114
F	15.80		16.50	0.622		0.650
G	20.40		21.10	0.803		0.831
H	15.10		15.50	0.594		0.610
J	5.40		5.65	0.213		0.222
K	1.10		1.40	0.043		0.055
L	1.35		1.50	0.053		0.059
P	2.80		3.00	0.110		0.118
R		4.35			0.171	

FIG.1: Maximum power dissipation versus RMS on-state current

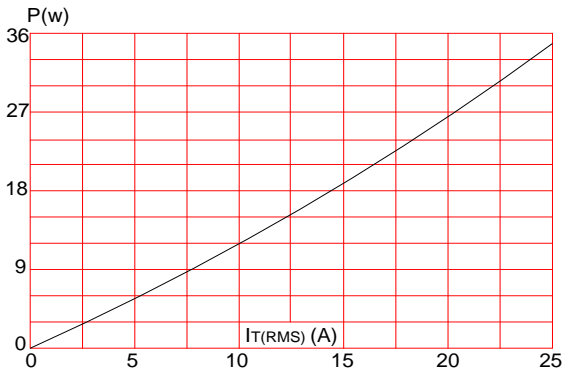

FIG.2: RMS on-state current versus case temperature

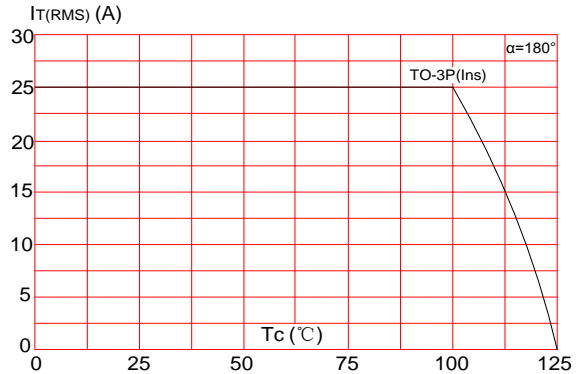

FIG.3: Surge peak on-state current versus number of cycles

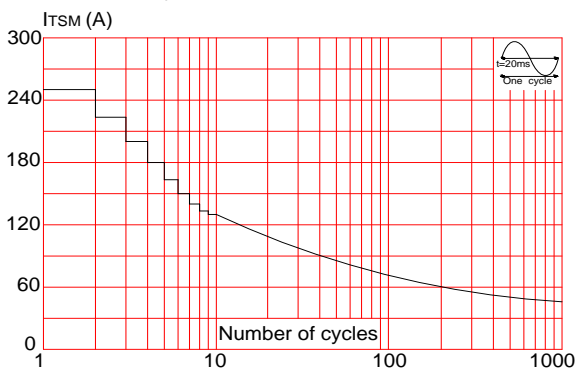

FIG.4: On-state characteristics (maximum values)

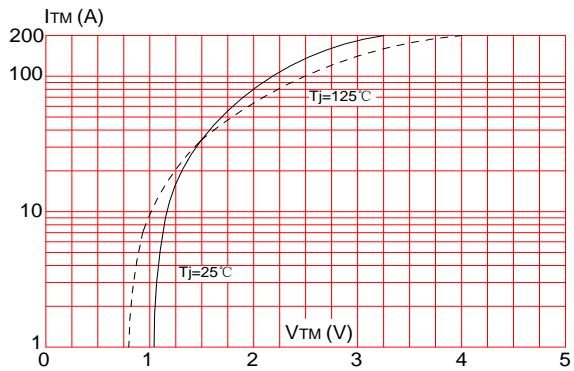

FIG.5: Non-repetitive surge peak on-state current for a sinusoidal pulse with width $t_p < 10\text{ms}$, and corresponding value of I^2t ($di/dt < 50\text{A}/\mu\text{s}$)

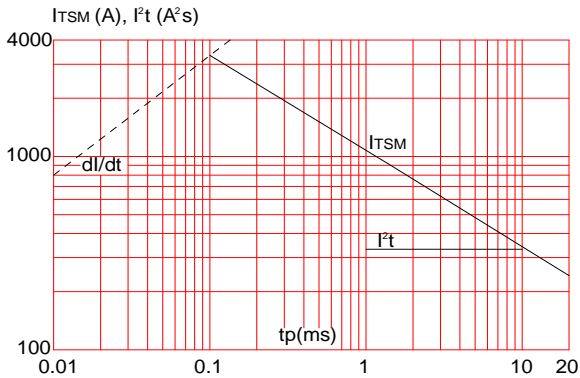
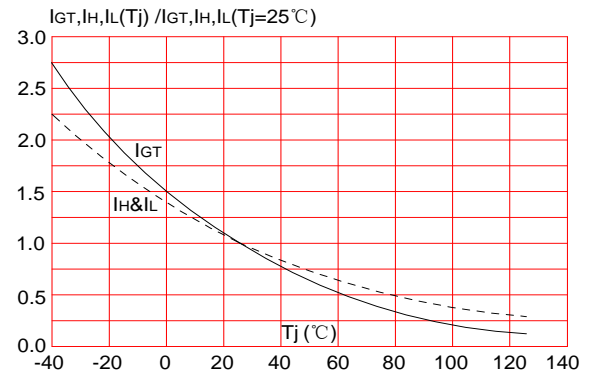



FIG.6: Relative variations of gate trigger current, holding current and latching current versus junction temperature



Information furnished in this document is believed to be accurate and reliable. However, Jiangsu JieJie Microelectronics Co.,Ltd assumes no responsibility for the consequences of use without consideration for such information nor use beyond it. Information mentioned in this document is subject to change without notice, apart from that when an agreement is signed, Jiangsu JieJie complies with the agreement. Products and information provided in this document have no infringement of patents. Jiangsu JieJie assumes no responsibility for any infringement of other rights of third parties which may result from the use of such products and information. This document is the first version which is made in 14-Jan.-2016. This document supersedes and replaces all information previously supplied.

 is a registered trademark of Jiangsu JieJie Microelectronics Co.,Ltd.
Copyright ©2016 Jiangsu JieJie Microelectronics Co.,Ltd. Printed All rights reserved.