

Features

- Transient protection for high-speed data lines
IEC 61000-4-2 (ESD) $\pm 15\text{kV}$ (Air)
 $\pm 8\text{kV}$ (Contact)
IEC 61000-4-4 (EFT) 40A (5/50 ns)
Cable Discharge Event (CDE)
- Package optimized for high-speed lines
- Ultra-small package (2.5mm \times 1.0mm \times 0.55mm)
- Protects four data lines
- Ultra Low capacitance: 0.6pF for each channel
- Low leakage current: 0.1 μA @ V_{RWM} (Typical)
- Low clamping voltage
- Each I/O pin can withstand over 1000 ESD strikes for $\pm 8\text{kV}$ contact discharge
- Pb free & RoHS Compliant

General Description

CS0806S is an ultra-low capacitance Transient Voltage Suppressor (TVS) designed to provide electrostatic discharge (ESD) protection for high-speed data interfaces. With typical capacitance of 0.6pF only, CS0806S is designed to protect parasitic-sensitive systems against over-voltage and over-current transient events. It complies with IEC 61000-4-2 (ESD), Level 4 ($\pm 15\text{kV}$ air, $\pm 8\text{kV}$ contact discharge), IEC 61000-4-4 (electrical fast transient - EFT) (40A, 5/50 ns), very fast charged device model (CDM) ESD and cable discharge event (CDE), etc.

CS0806S uses ultra-small DFN-10L package. Each CS0806S device can protect four high-speed data lines. The combined features of ultra-low capacitance, ultra-small size and high ESD robustness make CS0806S deal for high-speed data ports and high-frequency lines (e.g., HDMI & DVI) applications. The low clamping voltage of the CS0806S guarantees a minimum stress on the protected IC.

Applications

- Serial ATA
- PCI Express
- Desktops, Servers and Notebooks
- MDDI Ports
- USB2.0 Power and Data Line Protection
- Display Ports
- High Definition Multi-Media Interface (HDMI)
- Digital Visual Interfaces (DVI)

Mechanical Characteristics

- DFN-10L package
- Flammability Rating: UL 94V-0
- Marking: Part number, Date
- Packaging: Tape and Reel

Circuit Diagram

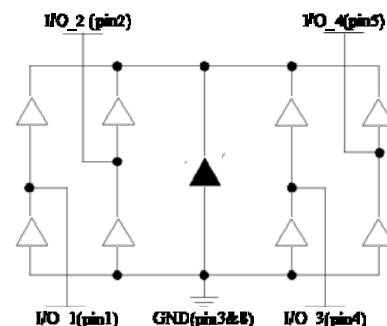

Pin Configuration

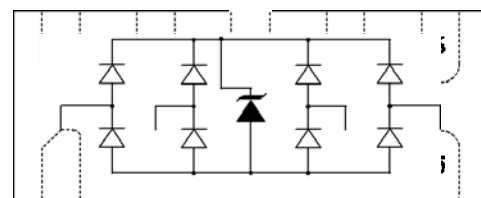

DFN-10L
(Top View)

Absolute Maximum Rating

Symbol	Parameter	Value	Units
V_{ESD}	ESD per IEC 61000-4-2 (Air)	±17	kV
	ESD per IEC 61000-4-2 (Contact)	±12	
I_{OPT}	Operating Temperature	-55/+125	°C
I_{STG}	Storage Temperature	-55/+150	°C

Electrical Characteristics (T = 25° C)

Symbol	Parameter
V_{RWM}	Nominal Reverse Working Voltage
I_R	Reverse Leakage Current @ V_{RWM}
V_{BR}	Reverse Breakdown Voltage @ I_T
I_T	Test Current for Reverse Breakdown
V_C	Clamping Voltage @ I_{PP}
I_{PP}	Maximum Peak Pulse Current
C_{ESD}	Parasitic Capacitance
V_R	Reverse Voltage
f	Small Signal Frequency
I_F	Forward Current
V_F	Forward Voltage @ I_F

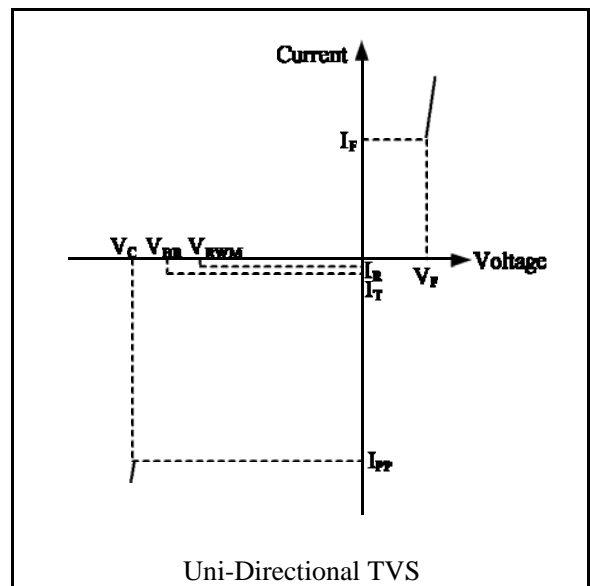

Symbol	Test Co dition	Minimum	Typical	Maximum	Units
V_{RWM}				5.0	V
I_R	$V_{RWM} = 5V, T = 25^\circ C$ Between I/O and GND		0.1	1.0	μA
V_{BR}	$I_T = 1mA$ Between I/O and GND	6.0	8.0	10.0	V
V_C	$I_{PP} = 1A, t_p = 8/20\mu s$ Between I/O and GND			12	V
C_{ESD}	$V_R = 0V, f = 1MHz$ Between I/O and GND		0.6	0.8	pF
C_{ESD}	$V_R = 0V, V_{pin3,8} = 0V, f = 1MHz$ Between I/O and I/O		0.05	0.08	pF



CS0806S

Ultra-Low Capacitance TVS Protection

Voltage Sweeping of I/O to GND

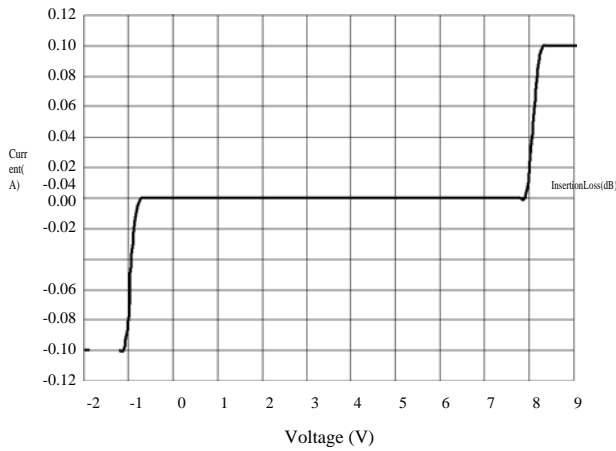

Insertion Loss S21 of I/O to GND

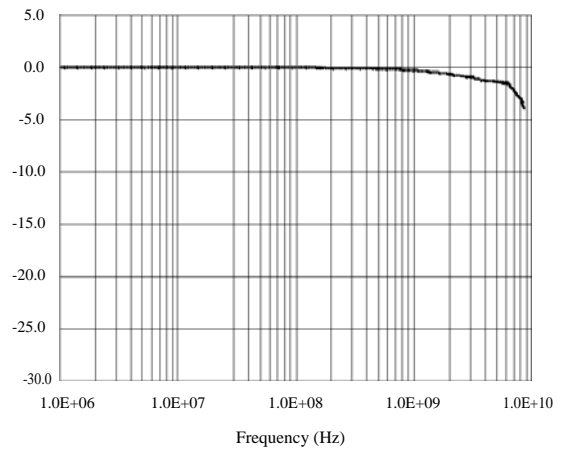

Capacitance vs. Voltage of I/O to GND (f = 1MHz)

Capacitance vs. Reverse Voltage

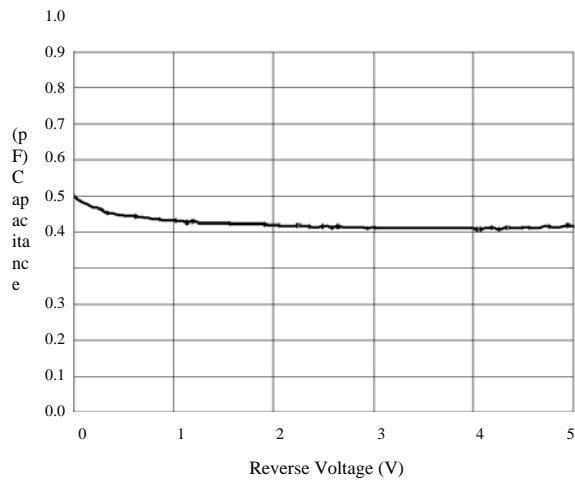

Normalized Capacitance vs. Reverse Voltage

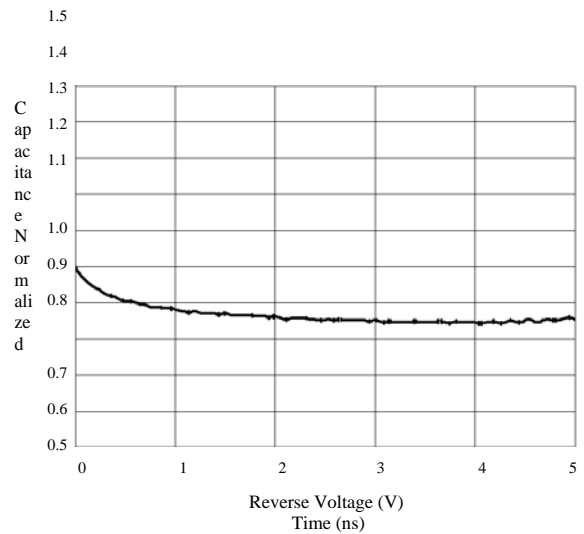

ESD Clamping of I/O to GND (+8kV Contact per IEC 61000-4-2)

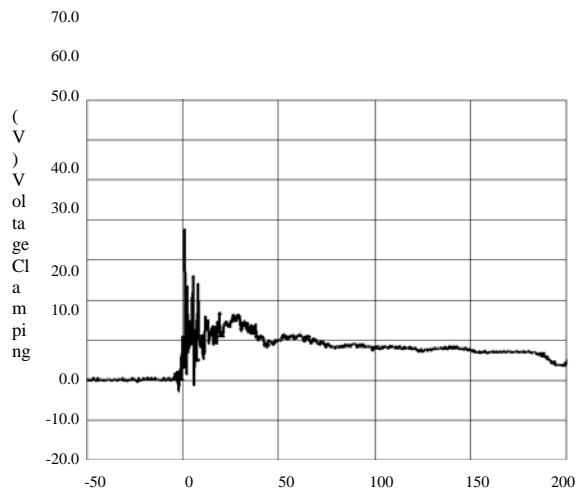

**ESD Clamping of I/O to GND
(-8kV Contact per IEC 61000-4-2)**

20.0
10.0
0.0
{V
}V -10.0

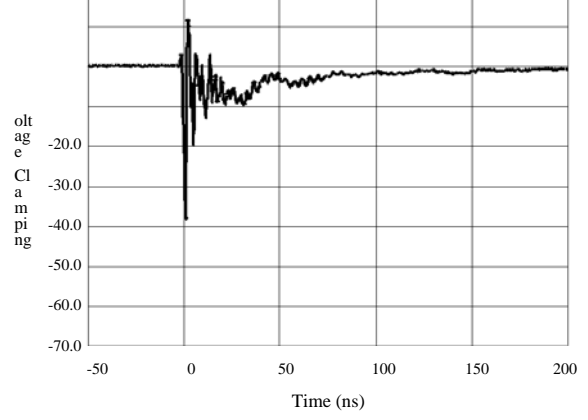

Application Information

Pin Connection in PCB

CS0806S provides ESD protection for four data lines simultaneously. The pin connection is shown in the figure below.

Four parallel data lines, from inner IC to I/O port connector, could connect to CS0806S four I/O pins directly. Pin 3&8 of CS0806S is the GND pin, which should connect to the GND of PCB. The wire should be as short as possible in order to minimize the parasitic inductance.

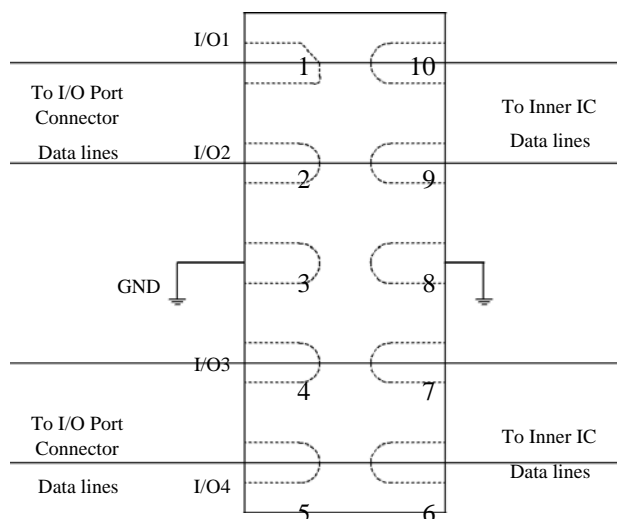

Figure 1 CS0806S pin connection in PCB

PCB Layout Guidelines

For optimum ESD protection and the whole circuit performance, the following PCB layout guidelines are recommended:

- CS0806S GND pin to the PCB GND rail path should be as short as possible. It could reduce the ESD transient return path to GND.
- The vias connecting CS0806S GND pins to the PCB GND should be wide.
- Place CS0806S as close to the connector port as possible. It could reduce the parasitic inductance and restrict ESD coupling into adjacent traces.
- Avoid running critical signals near board edges.

Application Information

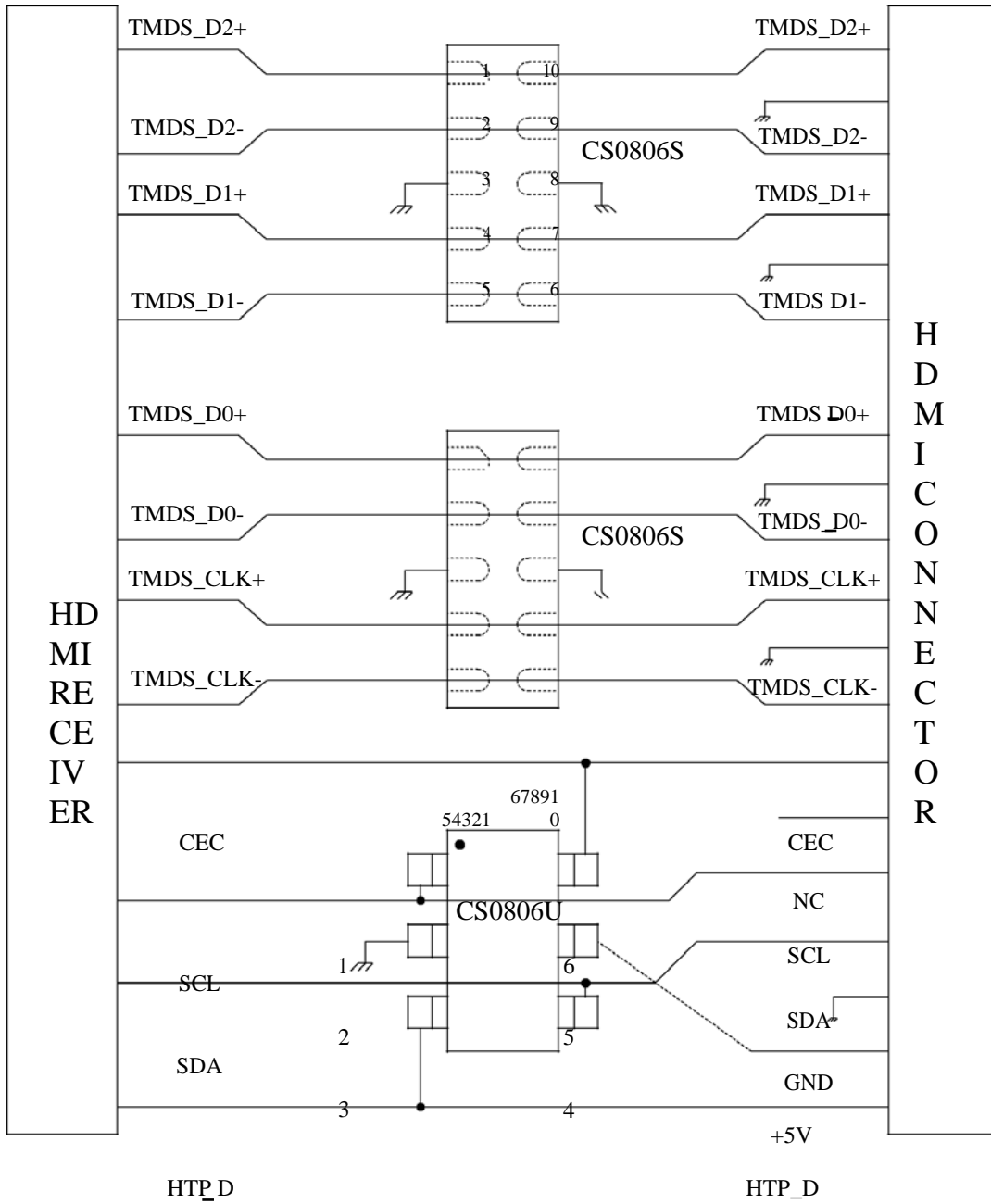

Figure 2 Layout Top View for HDMI Interface with CS0806S & CS0806U

Application Information

Eye Diagram Measurements for 1080P HDMI Data Transmission

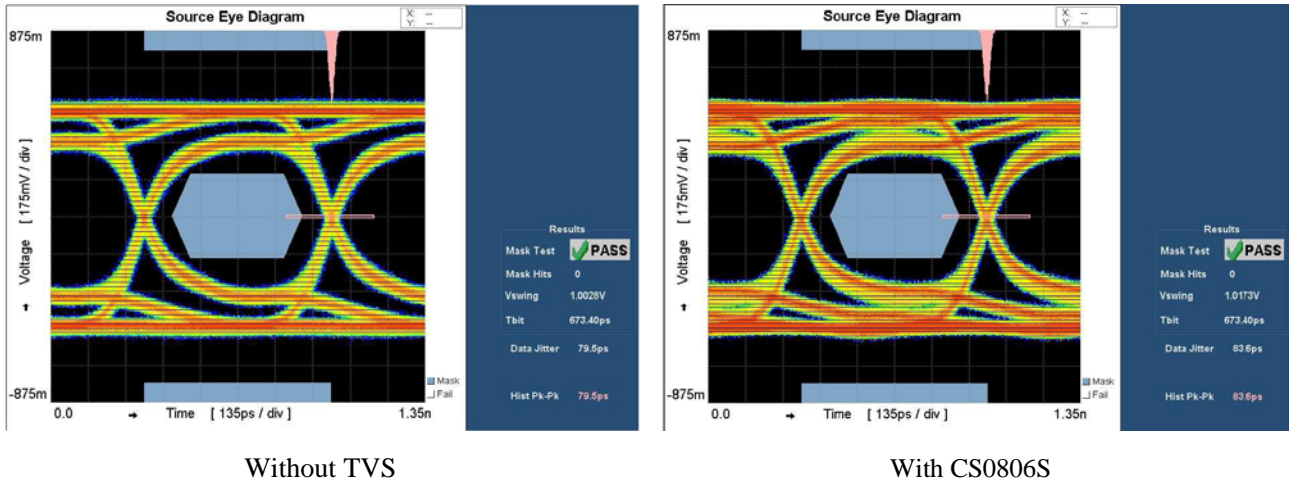

Figure 3 Eye Diagram Measurements for 1080P HDMI

TDR Measurements for HDMI

The combination of low capacitance, small package, and flow-through design means it is possible to use CS0806S to meet the HDMI impedance requirements of 100 Ohms \pm 15%. Figure 4 shows impedance test result for a TDR rise time of 100ps, using a CitrusCom evaluation board with 100 Ohm differential traces. Measurements were taken using a TDR method as outlined in the HDMI Compliance Test Specification (CTS). In this case, the device meets the HDMI CTS requirement of 100 Ohm \pm 15% with plenty of margin.



Figure 4 TDR Measurements for HDMI

Package Outline

- DFN-10L package
- Thermally-Enhanced
- MSL-1 Level

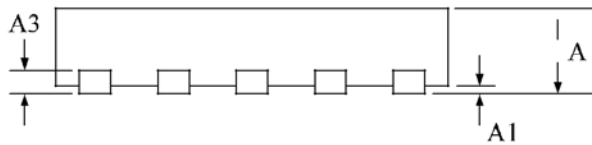
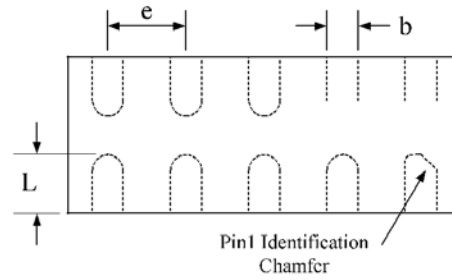

Package Dimensions (Controlling dimensions are in millimeters)

Symbol	Dimensions (mm)		Dimensions (Inches)	
	Minimum	Maximum	Minimum	Maximum
A	0.500	0.600	0.020	0.024
A1	0.000	0.050	0.000	0.002
A3	0.15REF.		0.006REF.	
b	0.150	0.250	0.006	0.010
D	2.450	2.550	0.096	0.100
E	0.950	1.050	0.037	0.041
e	0.500 BSC		0.020 BSC	
L	0.300	0.400	0.012	0.016

PCB Layout Pattern

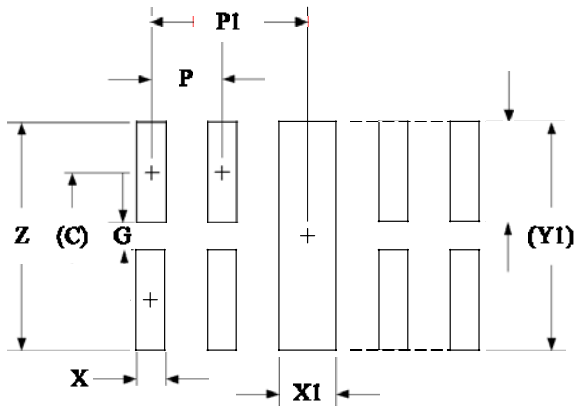

DIMENSIONS		
DIM	INCHES	MILLIMETERS
C	(0.034)	(0.875)
G	0.008	0.20
P	0.020	0.50
P1	0.039	1.00
X	0.008	0.20
X1	0.016	0.40
Y	0.027	0.675
Y1	(0.061)	(1.55)
Z	0.061	1.55

Tape and Reel Specification

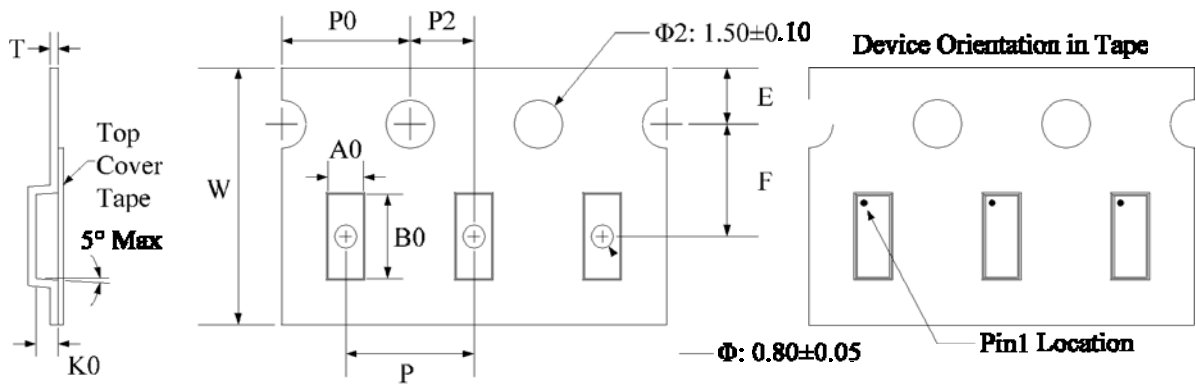

Symbol	W	A0	B0	K0	E	F	P	P0	P2	T
Dimensions (mm)	8.00+0.3 -0.1	1.23±0.05	2.7±0.05	0.7±0.05	1.75±0.1	3.5±0.05	4.0±0.1	4.0±0.1	2.0±0.05	0.25±0.02

Marking Codes

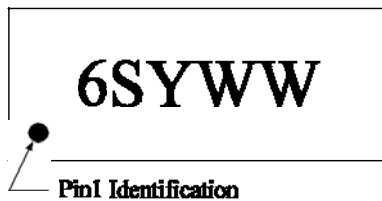

Ordering Information

Part Number	Working Voltage	Quantity Per Reel	Reel Size
CS0806S	5V	3,000	7 Inch

Note:

(1) "6S" is part number, while "YWW" is date code.