



# 2SA684

## PNP SILICON TRANSISTOR

### PNP SILICON TRANSISTOR

■ DESCRIPTION

The **UTC 2SA684** is power amplifier and driver.

■ FEATURES

- \* Automatic insertion by radial taping possible.
- \* Complementary pair with 2SC1384.

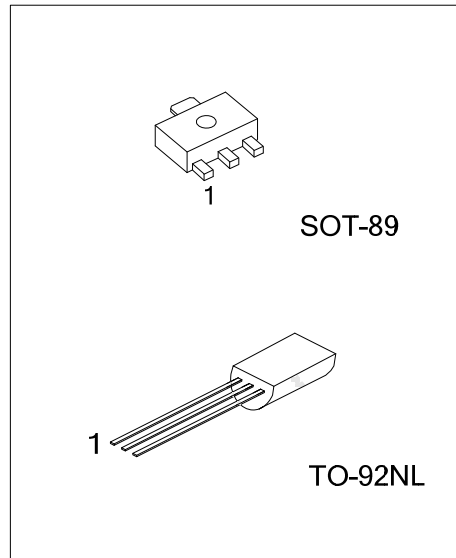

■ ORDERING INFORMATION

Ordering Number		Package	Pin Assignment			Packing
Lead Free	Halogen Free		1	2	3	
-	2SA684G-x-AB3-R	SOT-89	B	C	E	Tape Reel
2SA684L-x-T9N-B	2SA684G-x-T9N-B	TO-92NL	E	C	B	Tape Box
2SA684L-x-T9N-K	2SA684G-x-T9N-K	TO-92NL	E	C	B	Bulk

Note: Pin Assignment: B: Base C: Collector E: Emitter

<p>2SA684G-x-AB3-R</p>	<p>(1) R: Tape Reel, B: Tape Box, K: Bulk,                  (2) AB3: SOT-89, T9N: TO-92NL                  (3) x: refer to Classification of <math>h_{FE}</math>                  (4) G: Halogen Free and Lead Free, L: Lead Free</p>
------------------------	---

■ MARKING

SOT-89	TO-92NL

■ ABSOLUTE MAXIMUM RATINGS ( $T_A=25^\circ\text{C}$ , unless otherwise noted)

PARAMETER		SYMBOL	RATINGS	UNIT
Collector-Base Voltage		$V_{CBO}$	-60	V
Collector-Emitter Voltage		$V_{CEO}$	-50	V
Emitter-Base Voltage		$V_{EBO}$	-5	V
Peak Collector Current		$I_{CP}$	-1.5	A
Collector Current (DC)		$I_C$	-1	A
Collector Dissipation	SOT-89	$P_C$	500	mW
	TO-92NL		1000	mW
Junction Temperature		$T_J$	+150	$^\circ\text{C}$
Storage Temperature		$T_{STG}$	-55 ~ +150	$^\circ\text{C}$

Note: Absolute maximum ratings are those values beyond which the device could be permanently damaged.

Absolute maximum ratings are stress ratings only and functional device operation is not implied.

■ ELECTRICAL CHARACTERISTICS ( $T_A=25^\circ\text{C}$ , unless otherwise noted)

PARAMETER	SYMBOL	TEST CONDITIONS	MIN	TYP	MAX	UNIT
Collector-Base Breakdown Voltage	$BV_{CBO}$	$I_C=-10\mu\text{A}, I_E=0$	-60			V
Collector-Emitter Breakdown Voltage	$BV_{CEO}$	$I_C=-2\text{mA}, I_B=0$	-50			V
Emitter-Base Breakdown Voltage	$BV_{EBO}$	$I_E=-10\mu\text{A}, I_C=0$	-5			V
Collector Cut-Off Current	$I_{CBO}$	$V_{CB}=-20\text{V}, I_E=0$			-0.1	$\mu\text{A}$
DC Current Gain	$h_{FE1}$	$V_{CE}=-10\text{V}, I_C=-500\text{mA}$	85		340	
	$h_{FE2}$	$V_{CE}=-5\text{V}, I_C=-1\text{A}$	50			
Collector-Emitter Saturation Voltage	$V_{CE(SAT)}$	$I_C=-0.5\text{A}, I_B=-50\text{mA}$		-0.2	-0.4	V
Base-Emitter Saturation Voltage	$V_{BE(SAT)}$	$I_C=-0.5\text{A}, I_B=-50\text{mA}$		-0.85	-1.2	V
Current Gain Bandwidth Product	$f_T$	$V_{CE}=-10\text{V}, I_B=50\text{mA}, f=200\text{MHz}$		200		MHz
Output Capacitance	$C_{ob}$	$V_{CB}=-10\text{V}, I_E=0, f=1\text{MHz}$		20	30	pF

■ CLASSIFICATION OF  $h_{FE}$

RANK	Q	R	S
RANGE	85-170	120-240	170-340

### TYPICAL CHARACTERISTICS

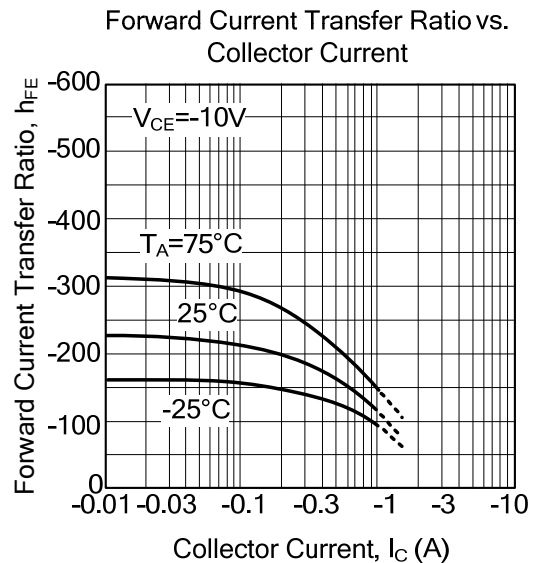
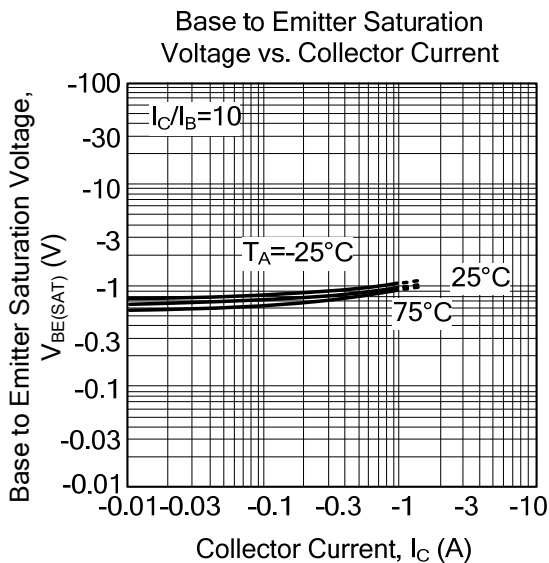
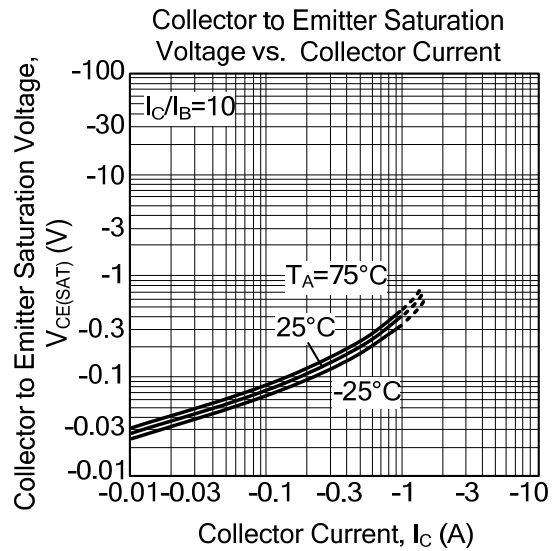
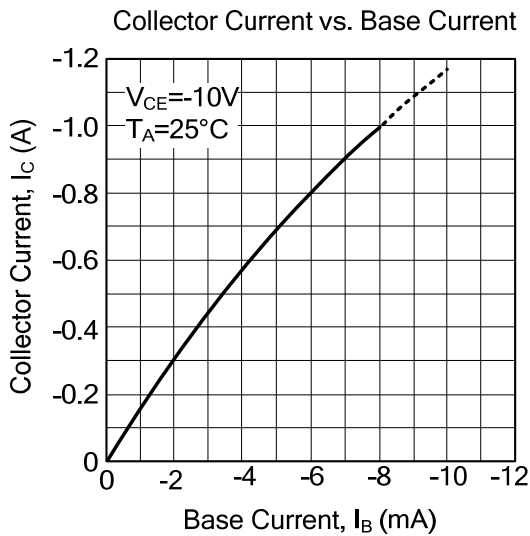
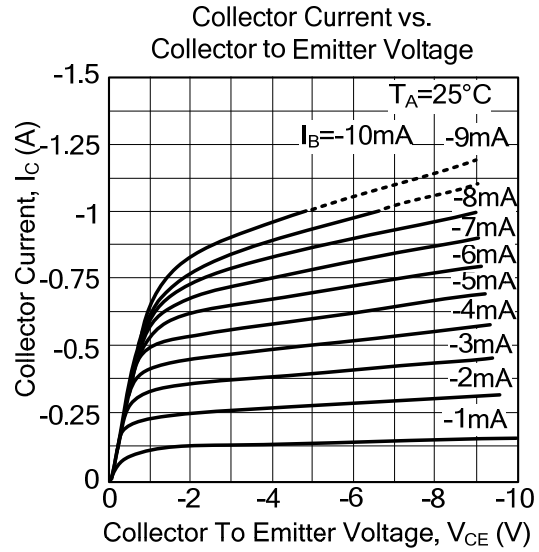
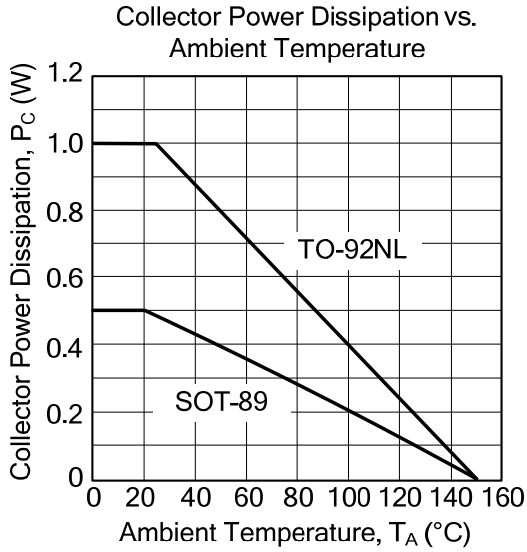

■ TYPICAL CHARACTERISTICS(Cont.)

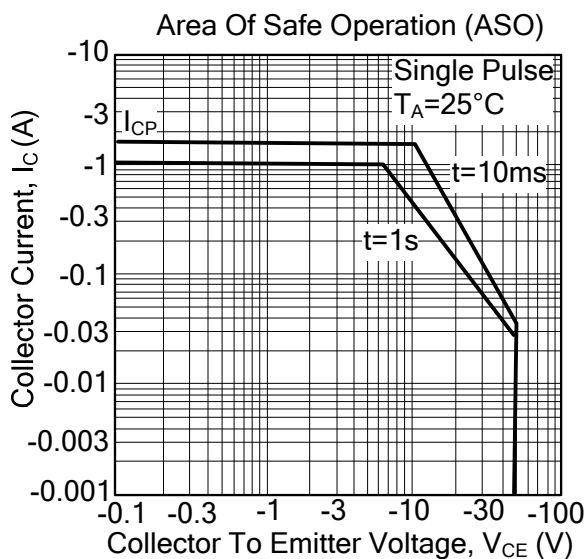
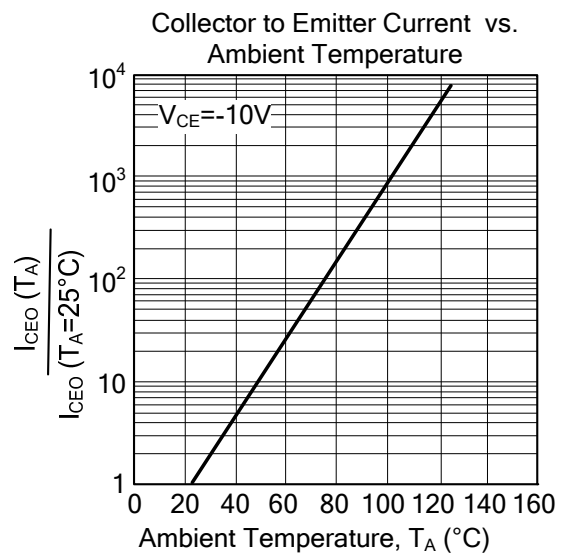
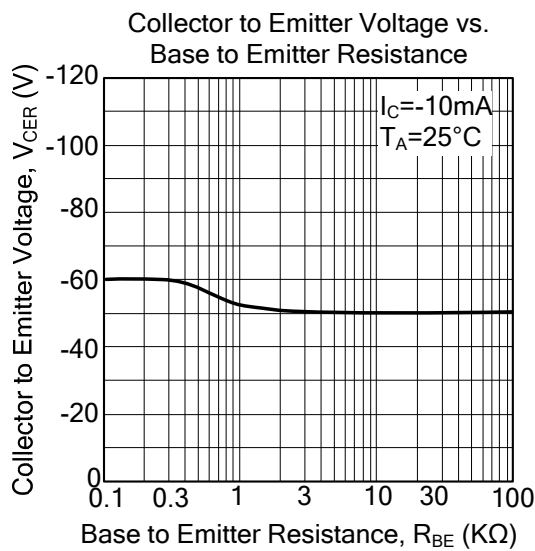
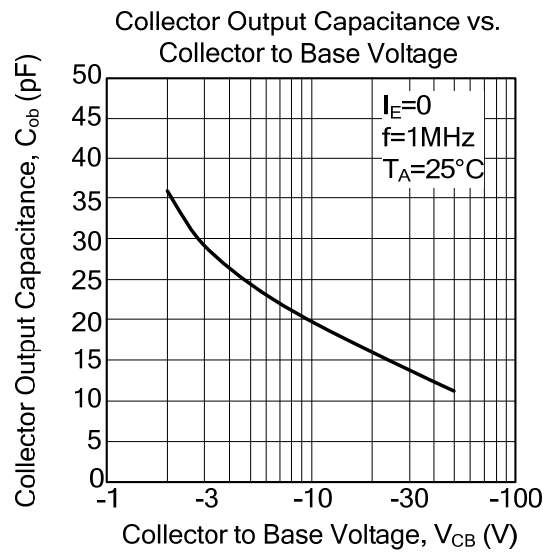
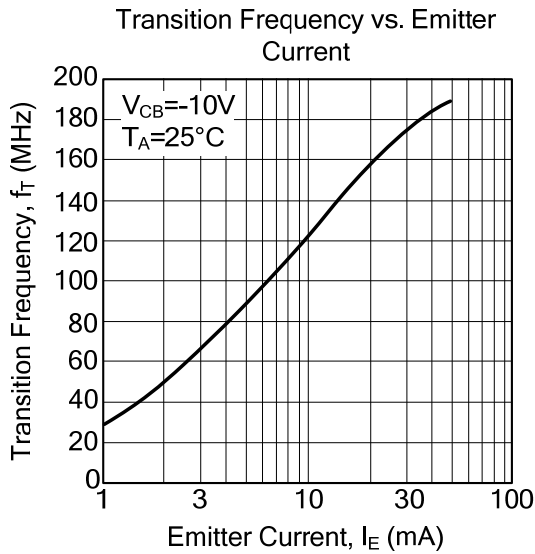

UTC assumes no responsibility for equipment failures that result from using products at values that exceed, even momentarily, rated values (such as maximum ratings, operating condition ranges, or other parameters) listed in products specifications of any and all UTC products described or contained herein. UTC products are not designed for use in life support appliances, devices or systems where malfunction of these products can be reasonably expected to result in personal injury. Reproduction in whole or in part is prohibited without the prior written consent of the copyright owner. The information presented in this document does not form part of any quotation or contract, is believed to be accurate and reliable and may be changed without notice.