

SPECIFICATIONS

Customer	
Product Name	Multi-layer Chip Ferrite Bead
Sunlord Part Number	UPZ Series
Customer Part Number	

New Released, Revised]

SPEC No.: **UPZ09150000**

【This SPEC is total 12 pages including specifications and appendix.】

【ROHS Compliant Parts 】

Approved By	Checked By	Issued By

Shenzhen Sunlord Electronics Co., Ltd.

Address: Sunlord Industrial Park, Dafuyuan Industrial Zone, Baoan, Shenzhen, China 518110
Tel: 0086-755-29832660 Fax: 0086-755-82269029 E-Mail: sunlord@sunlordinc.com

【For Customer approval Only】

Date: _____

Qualification Status: Full Restricted Rejected

Approved By	Verified By	Re-checked By	Checked By

Comments:

【Version change history】

Rev.	Effective Date	Changed Contents	Change Reasons	Approved By
01	/	New release	/	Hai Guo

1. Scope

This specification applies to UPZ Series of multi-layer ferrite chip bead.

2. Product Description and Identification (Part Number)

- 1) Description:
UPZ Series of Multi-layer ferrite chip bead.
- 2) Product Identification (Part Number)

$\underline{\text{UPZ}}$ $\underline{\text{※※※※}}$ $\underline{\text{○}}$ $\underline{\text{XXX}}$ $\underline{\square\square\square}$ $\underline{\text{◎}}$ $\underline{\text{F}}$
 ① ② ③ ④ ⑤ ⑥ ⑦

①	Type
UPZ	For Ultra Large current

②	External Dimensions(L X W) [mm]	
1005 [0402]	1.0 X 0.5	
1608 [0603]	1.65 X 0.8	
2012 [0805]	2.0 X 1.25	

③	Material Code
G, D, E, U	

④	Nominal Impedance
Example	Nominal Value
300	30Ω
121	120Ω

⑤	Rate Current
1R5	1.5A
3R0	3.0A

⑥	Packing
T	Tape Carrier Package

⑦	HSF Products
Hazardous Substance Free Products	

3. Electrical Characteristics

Please refer to **Appendix A** (Page 8~12).

- 1) Operating and storage temperature range (individual chip without packing): -55°C ~ +125°C
- 2) Storage temperature range (packaging conditions): -10°C~+40°C and RH 70% (Max.)

4. Shape and Dimensions

- 1) Dimensions and recommended PCB pattern for reflow soldering: See **Fig.4-1**, **Fig.4-2** and **Table 4-1**.
- 2) Structure: See **Fig. 4-3** and **Fig. 4-4**.

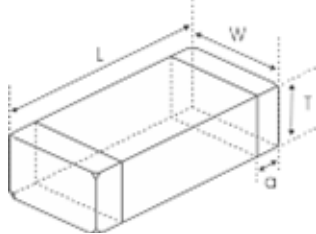

Fig. 4-1

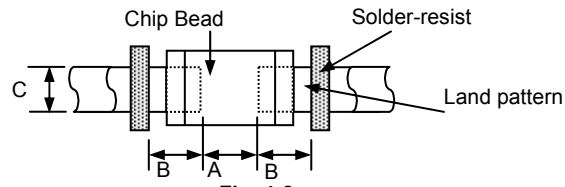

Fig. 4-2

[Table 4-1]

Unit: mm [inch]

Type	L	W	T	a	A	B	C
1005 [0402]	1.0±0.15 [0.039±0.006]	0.5±0.15 [0.020±0.006]	0.5±0.15 [0.020±0.006]	0.25±0.1 [0.010±0.004]	0.45~0.55	0.40~0.50	0.45~0.55
1608 [0603]	1.65±0.15 [0.065±0.006]	0.8±0.15 [0.031±0.006]	0.8±0.15 [0.031±0.006]	0.3±0.2 [0.012±0.008]	0.60~0.80	0.60~0.80	0.60~0.80
2012 [0805]	2.0 (+0.3, -0.1) [0.079(+0.012,-0.004)]	1.25±0.2 [0.049±0.008]	0.85±0.2 [0.033±0.008]	0.5±0.3 [0.020±0.012]	0.80~1.20	0.80~1.20	0.90~1.60

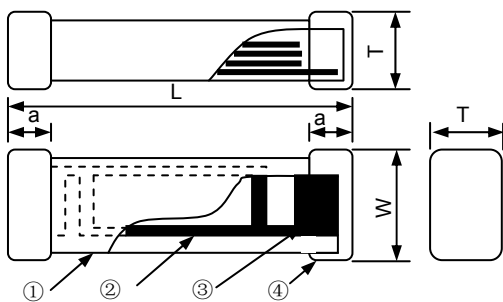

Fig. 4-3

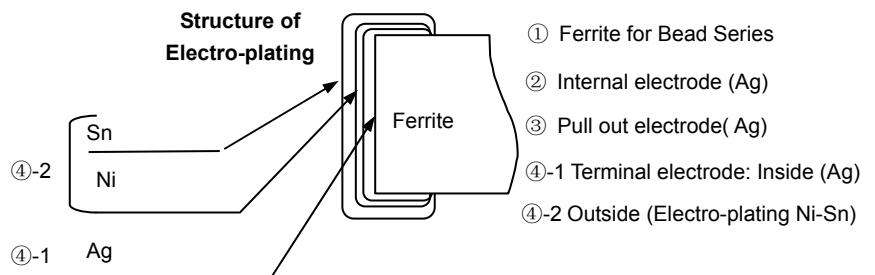

Fig. 4-4

3) Material Information: See **Table 4-2**.

[Table 4-2]

Code	Part Name	Material Name
①	Ferrite Body	Ferrite Powder
②	Inner Coils	Silver Paste
③	Pull-out Electrode (Ag)	Silver Paste
④-1	Terminal Electrode: Inside Ag	Termination Silver Composition
④-2	Electro-Plating: Ni/Sn plating	Plating Chemicals

5. Test and Measurement Procedures

5.1 Test Conditions

Unless otherwise specified, the standard atmospheric conditions for measurement/test as:

- a. Ambient Temperature: 20±15℃
- b. Relative Humidity: 65±20%
- c. Air Pressure: 86kPa to 106kPa

If any doubt on the results, measurements/tests should be made within the following limits:

- a. Ambient Temperature: 20±2℃
- b. Relative Humidity: 65±5%
- c. Air Pressure: 86kPa to 106kPa

5.2 Visual Examination

- a. Inspection Equipment: 20× magnifier

5.3 Electrical Test

5.3.1 DC Resistance (DCR)

- a. Refer to **Appendix A**.
- b. Test equipment (Analyzer): High Accuracy Milliohmmeter-HP4338B or equivalent.

5.3.2 Impedance (Z)

- a. Refer to **Appendix A**.
- b. Test equipment: High Accuracy RF Impedance /Material Analyzer-E4991A or equivalent.
Test fixture: HP16192A; Test signal: -20dBm or 50mV
- c. Test frequency refers to **Appendix A**.

5.3.3 Rated Current

- a. Refer to **Appendix A**.
- b. Test equipment (see **Fig. 5.3.3-1**): Electric Power, Electric current meter, Thermometer.
- c. Measurement method (see **Fig. 5.3.3-1**):
 1. Set test current to be 0 mA.
 2. Measure initial temperature of chip surface.
 3. Gradually increase voltage and measure chip temperature for corresponding current.
- d. Definition of Rated Current (I_r): I_r is direct electric current as chip surface temperature raises just 20℃. against chip initial surface temperature(T_a). (see **Fig. 5.3.3-2**):

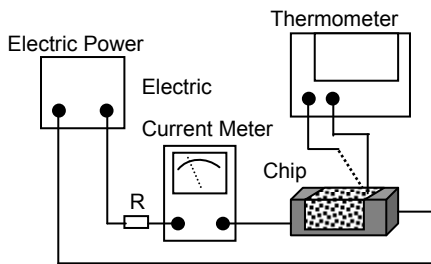

Fig. 5.3.3-1

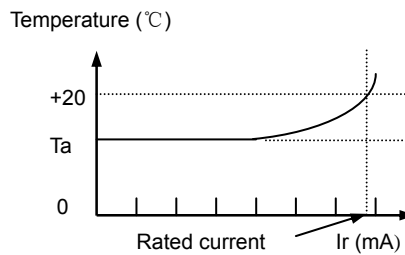
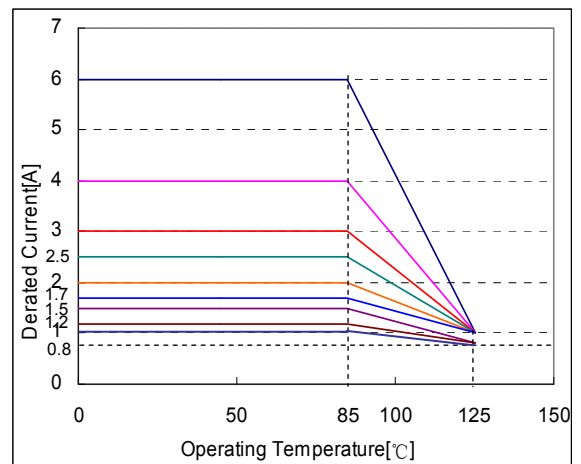
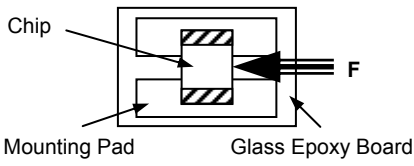
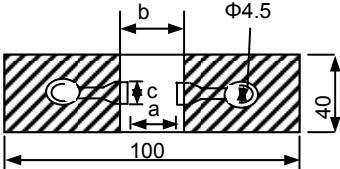
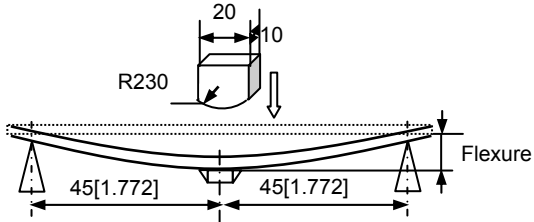
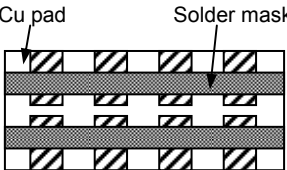
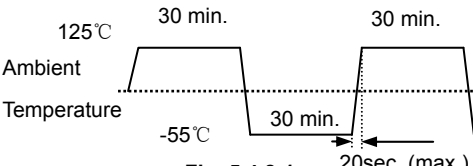

Fig. 5.3.3-2

- e. In operating temperatures exceeding +85℃, derating of current is necessary for chip ferrite beads for which rated current is 1000mA and over. Please apply the derating curve shown in chart according to the operating temperature.



5.4 Reliability Test

Items	Requirements	Test Methods and Remarks																
5.4.1 Terminal Strength	No removal or split of the termination or other defects shall occur.  Fig.5.4.1-1	<ol style="list-style-type: none"> Solder the bead to the testing jig (glass epoxy board shown in Fig. 5.4.1-1) using leadfree solder. Then apply a force in the direction of the arrow. 5N force for 1005 and 1608 series, 10N force for 2012 series. Keep time: 10±1s. Speed: 1.0mm/s. 																
5.4.2 Resistance to Flexure	No visible mechanical damage. Unit: mm [inch] <table border="1" data-bbox="325 600 756 775"> <thead> <tr> <th>Type</th> <th>a</th> <th>b</th> <th>c</th> </tr> </thead> <tbody> <tr> <td>1005[0402]</td> <td>0.4</td> <td>1.5</td> <td>0.5</td> </tr> <tr> <td>1608[0603]</td> <td>1.0</td> <td>3.0</td> <td>1.2</td> </tr> <tr> <td>2012[0805]</td> <td>1.2</td> <td>4.0</td> <td>1.65</td> </tr> </tbody> </table>  Fig. 5.4.2-1	Type	a	b	c	1005[0402]	0.4	1.5	0.5	1608[0603]	1.0	3.0	1.2	2012[0805]	1.2	4.0	1.65	<ol style="list-style-type: none"> Solder the bead to the test jig (glass epoxy board shown in Fig. 5.4.2-1) Using a leadfree solder. Then apply a force in the direction shown Fig. 5.4.2-2. Flexure: 2mm. Pressurizing Speed: 0.5mm/sec. Keep time: 30 sec.  Fig. 5.4.2-2
Type	a	b	c															
1005[0402]	0.4	1.5	0.5															
1608[0603]	1.0	3.0	1.2															
2012[0805]	1.2	4.0	1.65															
5.4.3 Vibration	<ol style="list-style-type: none"> No visible mechanical damage. Impedance change: within ±20%.  Glass Epoxy Board Fig. 5.4.3-1	<ol style="list-style-type: none"> Solder the bead to the testing jig (glass epoxy board shown in Fig. 5.4.3-1) using leadfree solder. The bead shall be subjected to a simple harmonic motion having total amplitude of 1.5mm, the frequency being varied uniformly between the approximate limits of 10 and 55 Hz. The frequency range from 10 to 55 Hz and return to 10 Hz shall be traversed in approximately 1 minute. This motion shall be applied for a period of 2 hours in each 3 mutually perpendicular directions (total of 6 hours). 																
5.4.4 Dropping	<ol style="list-style-type: none"> No visible mechanical damage. Impedance change: within ±20%. 	Drop chip bead 10 times on a concrete floor from a height of 100 cm.																
5.4.5 Temperature	Impedance change should be within ±20% of initial value measuring at 20°C.	Temperature range: -55°C ~ +125°C. Reference temperature: +20°C.																
5.4.6 Solderability	<ol style="list-style-type: none"> No visible mechanical damage. Wetting shall exceed 95% coverage. 	<ol style="list-style-type: none"> Solder temperature: 240±2°C. Duration: 3 sec. Solder: Sn/3.0Ag/0.5Cu. Flux: 25% Resin and 75% ethanol in weight. 																
5.4.7 Resistance to Soldering Heat	<ol style="list-style-type: none"> No visible mechanical damage. Wetting shall exceed 95% coverage. Impedance change: within ±20%. 	<ol style="list-style-type: none"> Solder temperature: 260±3°C Duration: 5 sec. Solder: Sn/3.0Ag/0.5Cu. Flux: 25% Resin and 75% ethanol in weight. The chip shall be stabilized at normal condition for 1~2 hours before measuring. 																
5.4.8 Thermal Shock	<ol style="list-style-type: none"> No mechanical damage. Impedance change: Within ±20%  Fig. 5.4.8-1	<ol style="list-style-type: none"> Temperature, Time: (See Fig. 5.4.8-1) -55°C for 30±3 min→125°C for 30±3min Transforming interval: Max. 20 sec. Tested cycle: 100 cycles. The chip shall be stabilized at normal condition for 1~2 hours before measuring. 																

5.4.9 Resistance to Low Temperature	① No mechanical damage. ② Impedance change: within $\pm 20\%$	① Temperature: $-55\pm 2^{\circ}\text{C}$ ② Duration: 1000^{+24} hours. ③ The chip shall be stabilized at normal condition for 1~2 hours before measuring.
5.4.10 Resistance to High Temperature	① No mechanical damage. ② Impedance change: within $\pm 20\%$	① Temperature: $125\pm 2^{\circ}\text{C}$. ② Duration: 1000^{+24} hours. ③ The chip shall be stabilized at normal condition for 1~2 hours before measuring.
5.4.11 Damp Heat (Steady States)	① No visible mechanical damage. ② Impedance change: within $\pm 20\%$	① Temperature: $60\pm 2^{\circ}\text{C}$. ② Humidity: 90% to 95% RH. ③ Duration: 1000^{+24} hours. ④ The chip shall be stabilized at normal condition for 1~2 hours before measuring.
5.4.12 Loading Under Damp Heat	① No visible mechanical damage. ② Impedance change: within $\pm 20\%$	① Temperature: $60\pm 2^{\circ}\text{C}$. ② Humidity: 90% to 95% RH. ③ Duration: 1000^{+24} hours. ④ Applied current: Rated current. ⑤ The chip shall be stabilized at normal condition for 1~2 hours before measuring.
5.4.13 Loading at High Temperature (Life Test)	① No visible mechanical damage. ② Impedance change: within $\pm 20\%$	① Temperature: $85\pm 2^{\circ}\text{C}$ ② Duration: 1000^{+24} hours. ③ Applied current: Rated current. ④ The chip shall be stabilized at normal condition for 1~2 hours before measuring.

6. Packaging and Storage

6.1 Packaging

Tape Carrier Packaging:

Packaging code: T

- a. Tape carrier packaging are specified in attached figure Fig. 6.1-1~3
- b. Tape carrier packaging quantity please see the following table:

Type	1005[0402]	1608[0603]	2012[0805]
T(mm)	0.5 ± 0.15	0.8 ± 0.15	0.85 ± 0.2
Tape	Paper Tape	Paper Tape	Paper Tape
Quantity	10K	4K	4K

(1) Taping Drawings (Unit: mm)

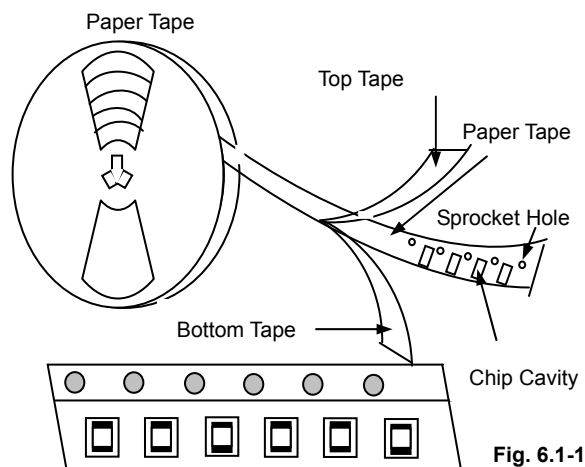

Remark: The sprocket holes are to the right as the tape is pulled toward the user.

(2) Taping Dimensions (Unit: mm)

Sprocket Hole $\Phi 1.5 (+0.1,0)$

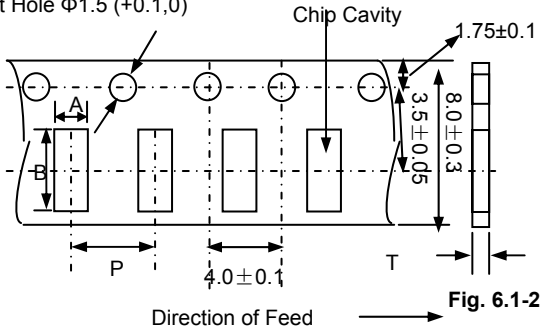

Paper Tape

Type	A	B	P	T max
1005[0402]	0.65 ± 0.1	1.15 ± 0.1	2.0 ± 0.05	0.8
1608[0603]	1.0 ± 0.2	1.8 ± 0.2	4.0 ± 0.1	1.1
2012[0805]	1.5 ± 0.2	2.3 ± 0.2	4.0 ± 0.1	1.1

(3) Reel Dimensions (Unit: mm)

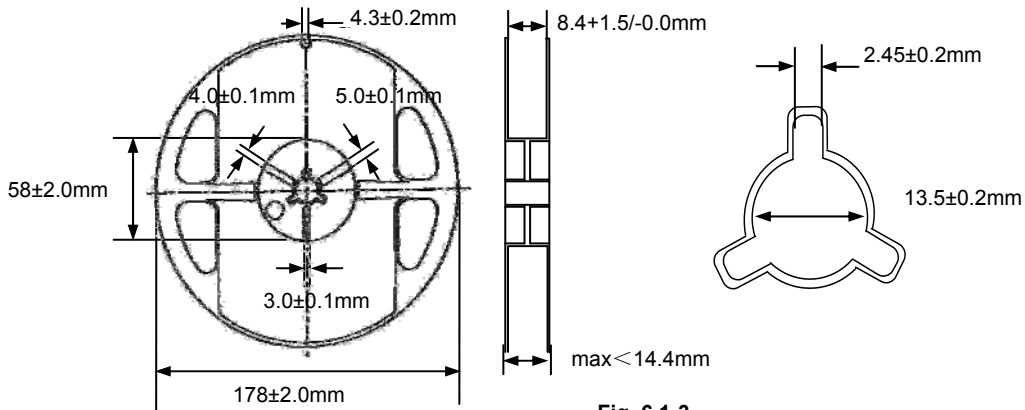

Fig. 6.1-3

6.2 Storage

- a. The solderability of the external electrode may be deteriorated if packages are stored where they are exposed to high humidity. Package must be stored at 40°C or less and 70% RH or less.
- b. The solderability of the external electrode may be deteriorated if packages are stored where they are exposed to dust or harmful gas (e.g. HCl, sulfurous gas of H_2S).
- c. Packaging material may be deformed if package are stored where they are exposed to heat or direct sunlight.
- d. Solderability specified in **Clause 5.4.6** shall be guaranteed for 12 months from the date of delivery on condition that they are stored at the environment specified in **Clause 3**. For those parts, which passed more than 12 months shall be checked solder-ability before use.

7. Recommended Soldering Technologies

7.1 Reflowing Profile:

- △ Preheat condition: $150 \sim 200^\circ\text{C} / 60 \sim 120$ sec.
- △ Allowed time above 217°C : $60 \sim 90$ sec.
- △ Max temp: 260°C
- △ Max time at max temp: 10sec.
- △ Solder paste: Sn/3.0Ag/0.5Cu
- △ Allowed Reflow time: 2x max

[Note: The reflow profile in the above table is only for qualification and is not meant to specify board assembly profiles. Actual board assembly profiles must be based on the customer's specific board design, solder paste and process, and should not exceed the parameters as the Reflow profile shows.]

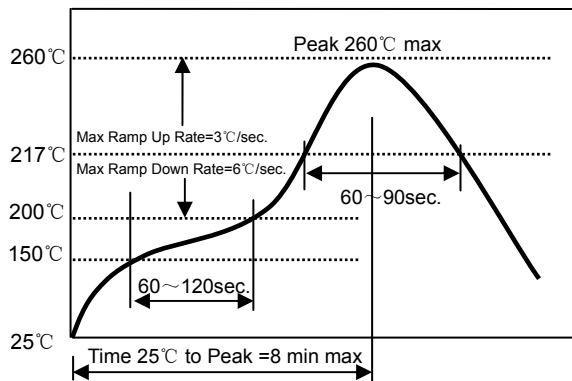

7.2 Iron Soldering Profile.

- △ Iron soldering power: Max.30W
- △ Pre-heating: $150^\circ\text{C} / 60$ sec.
- △ Soldering Tip temperature: 350°C Max.
- △ Soldering time: 3sec Max.
- △ Solder paste: Sn/3.0Ag/0.5Cu
- △ Max.1 times for iron soldering

[Note: Take care not to apply the tip of the soldering iron to the terminal electrodes.]

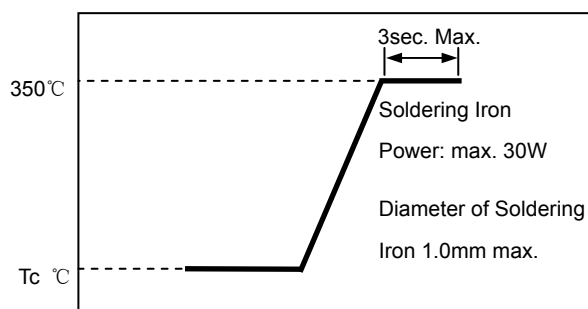

8. Supplier Information

- a) Supplier:
Shenzhen Sunlord Electronics Co., Ltd.
- b) Manufacturer:
Shenzhen Sunlord Electronics Co., Ltd.
- c) Manufacturing Address:
Sunlord Industrial Park, Dafuyuan Industrial Zone, Guanlan, Shenzhen, China 518110

Appendix A: Electrical Characteristics

I. UPZ1005 Series

Part Number	Impedance (Ω)	Z Test Freq. (MHz)	DCR (m Ω) Max.	I _r (mA) Max.	Thickness (mm) [inch]
UPZ1005D100-2R0TF	0~30	100	45	2000	0.5±0.15 [.020±.006]
UPZ1005D300-1R7TF	30±25%	100	50	1700	
UPZ1005D300-2R2TF	30±25%	100	35	2200	
UPZ1005D600-1R5TF	60±25%	100	75	1500	
UPZ1005D800-1R5TF	80±25%	100	70	1500	
UPZ1005D121-1R3TF	120±25%	100	90	1300	
UPZ1005D221-R90TF	220±25%	100	160	900	

II. UPZ1608 Series

Part Number	Impedance (Ω)	Z Test Freq. (MHz)	DCR (m Ω) Max.	I _r (mA) Max.	Thickness (mm) [inch]
UPZ1608G300-1R8TF	30±25%	100	60	1800	0.8±0.15 [.031±.006]
UPZ1608G600-1R2TF	60±25%	100	100	1200	
UPZ1608G101-1R0TF	100±25%	100	150	1000	
UPZ1608U220-6R0TF	22±25%	100	10	6000	
UPZ1608U280-6R0TF	28±25%	100	10	6000	
UPZ1608U700-4R0TF	70±25%	100	20	4000	
UPZ1608U221-2R2TF	220±25%	100	50	2200	
UPZ1608U331-1R5TF	330±25%	100	70	1500	
UPZ1608U391-1R5TF	390±25%	100	120	1500	
UPZ1608U471-1R5TF	470±25%	100	120	1500	
UPZ1608U601-1R3TF	600±25%	100	150	1300	
UPZ1608E300-5R0TF	30±25%	100	10	5000	
UPZ1608E600-3R5TF	60±25%	100	20	3500	
UPZ1608E101-3R0TF	100±25%	100	30	3000	
UPZ1608E181-2R2TF	180±25%	100	50	2200	
UPZ1608E221-2R2TF	220±25%	100	50	2200	
UPZ1608E331-1R7TF	330±25%	100	80	1700	
UPZ1608E601-1R0TF	600±25%	100	150	1000	
UPZ1608W260-6R0TF	26±25%	100	7	6000	

III. UPZ2012 Series

Part Number	Impedance (Ω)	Z Test Freq. (MHz)	DCR (m Ω) Max.	I _r (mA) Max.	Thickness (mm) [inch]
UPZ2012D220-6R0TF	22±25%	100	10	6000	0.85±0.2 [.033±.008]
UPZ2012D800-4R0TF	80±25%	100	20	4000	
UPZ2012U220-6R0TF	22±25%	100	10	6000	
UPZ2012U300-6R0TF	30±25%	100	10	6000	
UPZ2012U600-4R0TF	60±25%	100	20	4000	
UPZ2012U221-3R0TF	220±25%	100	40	3000	
UPZ2012E300-6R0TF	30±25%	100	10	6000	
UPZ2012E121-4R0TF	120±25%	100	20	4000	
UPZ2012E221-3R0TF	220±25%	100	40	3000	
UPZ2012E331-2R5TF	330±25%	100	50	2500	
UPZ2012E601-2R0TF	600±25%	100	90	2000	
UPZ2012E102-1R5TF	1000±25%	100	120	1500	

Impedance Frequency Characteristics

UPZ1005 Series

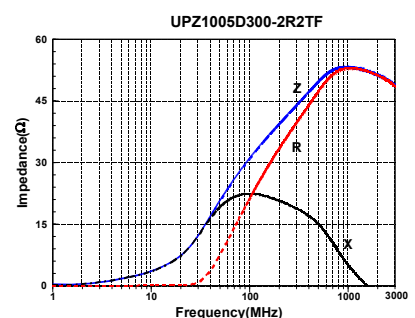
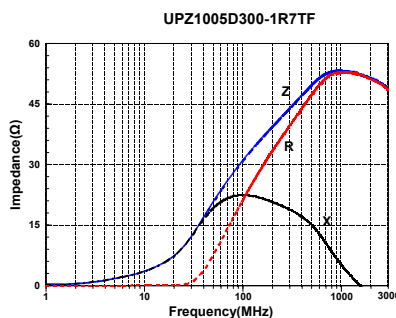
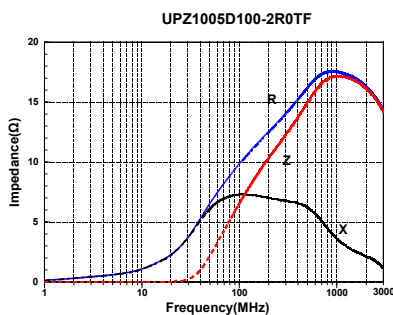

UPZ1005 Series

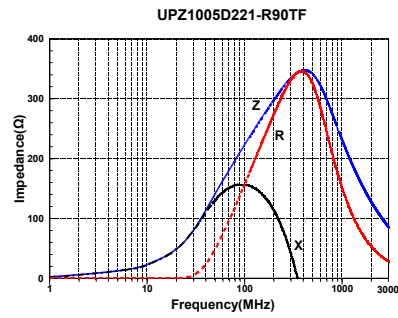
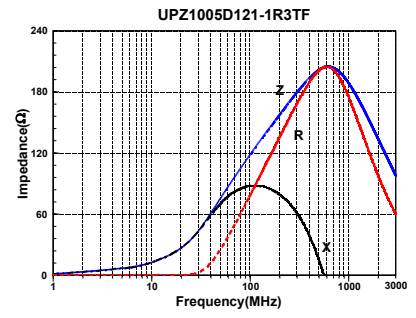
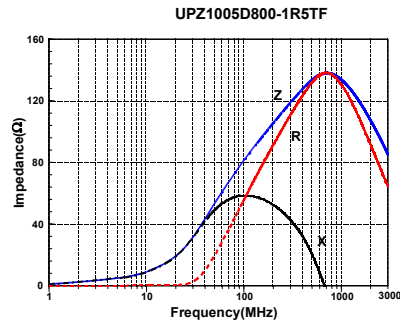
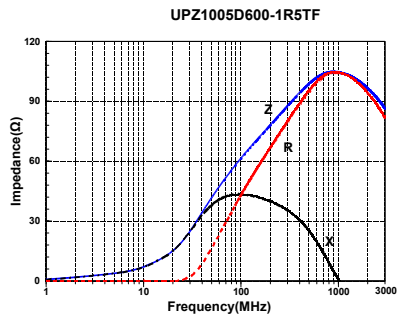

UPZ1608 Series

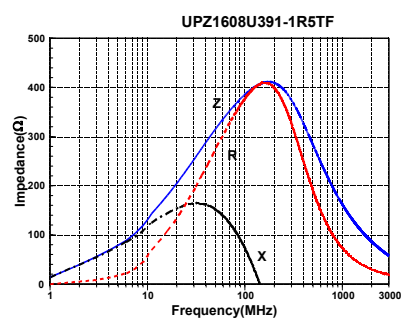
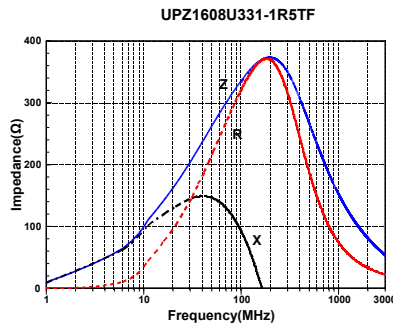
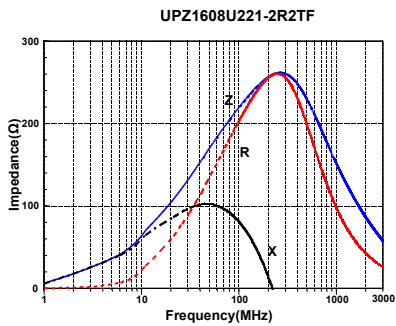
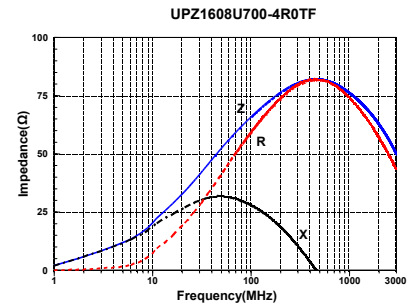
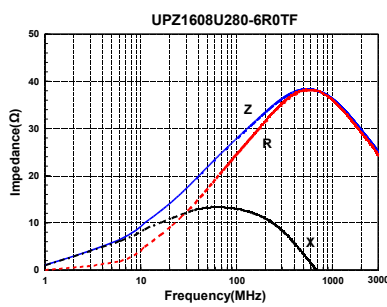
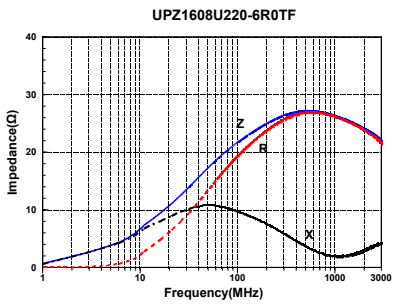
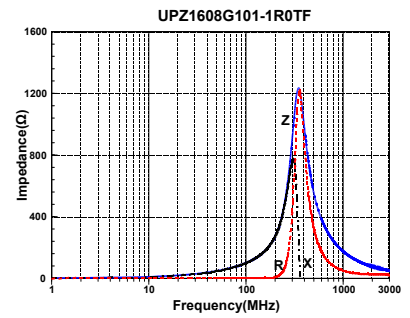
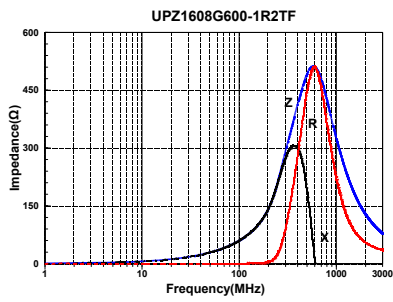
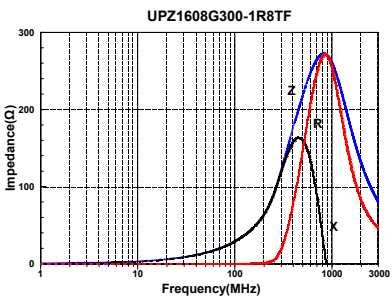

UPZ1608 Series

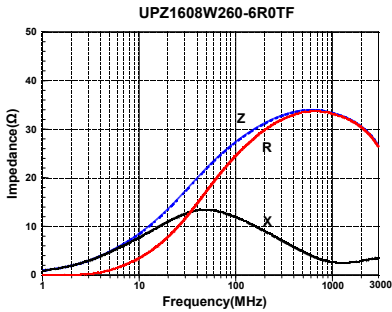
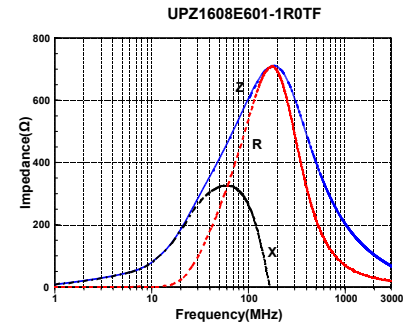
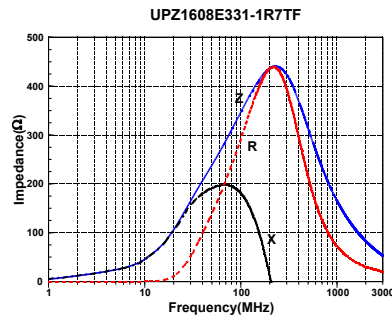
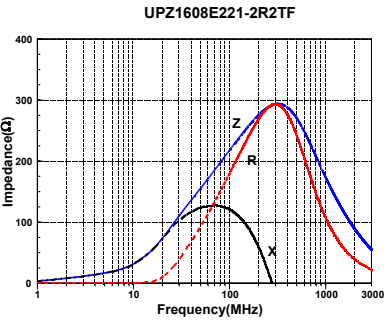
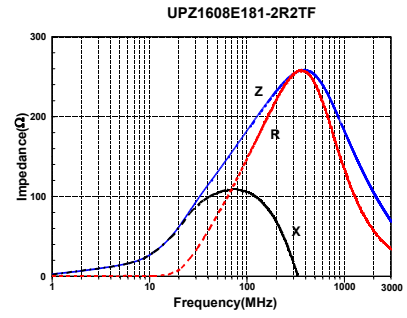
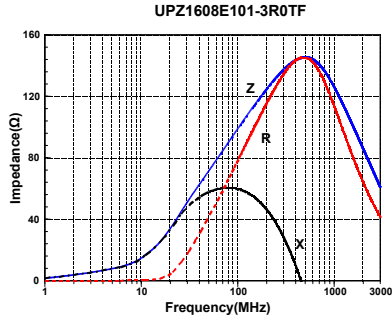
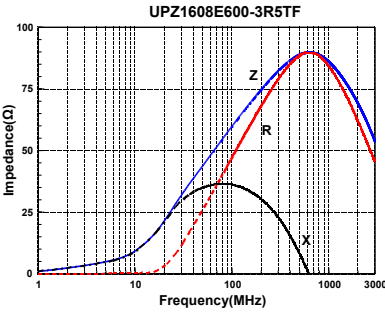
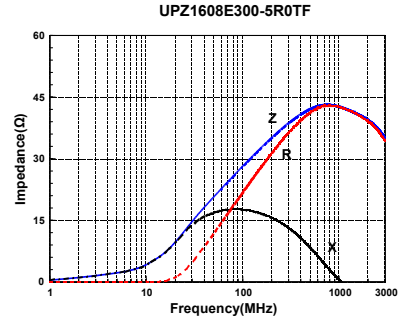
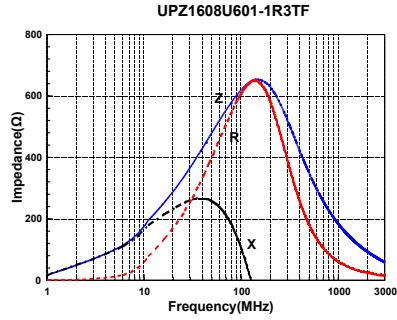
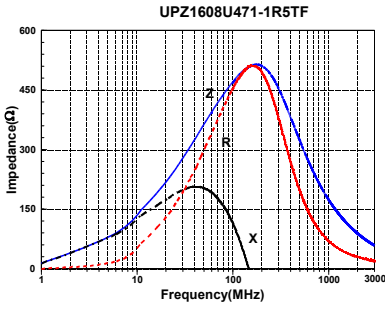

UPZ2012 Series

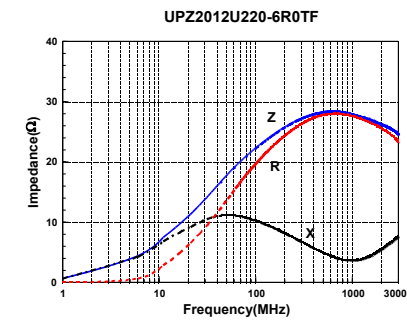
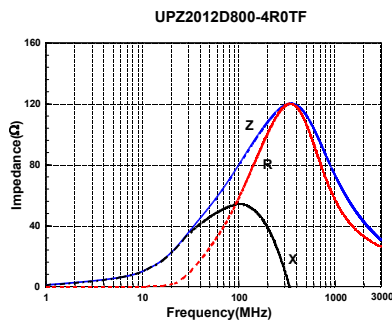
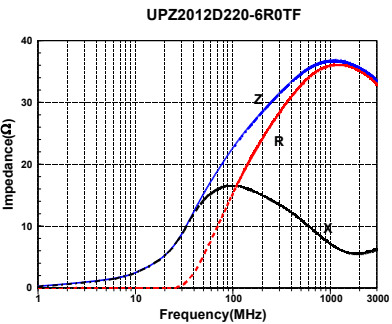

UPZ2012 Series

