



SGPD220S thru SGPD2BS

Surface Mount Schottky Rectifier
Reverse Voltage 20~100V Forward Current 0.2A

Features

- Low VF Schottky barrier diodes
- Very low profile - typical height of 1.0 mm
- Low forward voltage drop
- Low leakage current
- Moisture sensitivity: level 1, per J-STD-020
- High temperature soldering guaranteed: 260°C/10 seconds
- Halogen-free according to IEC 61249-2-21 definition



RoHS
COMPLIANT

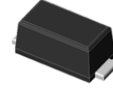

eSGP(SOD-323F)

Typical Applications

For use of fast swiching in RF module, lighting, cellular phone, portable device, power supplies and other consumer applications.

Maximum Ratings (TA = 25 °C unless otherwise noted)						
Parameter	Symbol	SGPD220S	SGPD240S	SGPD260S	SGPD2BS	Unit
Maximum repetitive peak reverse voltage	VRRM	20	40	60	100	V
Maximum RMS voltage	VRMS	14	28	42	70	V
Maximum DC blocking voltage	VDC	20	40	60	100	V
Maximum average forward rectified current	IF(AV)	0.2				A
Peak forward surge current 8.3 ms single half sine-wave superimposed on rated load	IFSM	10				A
Operating junction and storage temperature range	TJ, TSTG	- 55 to + 150				°C

Electrical Characteristics (TA = 25 °C unless otherwise noted)							
Parameter	Test Conditions	Symbol	SGPD220S	SGPD240S	SGPD260S	SGPD2BS	Unit
Maximum instantaneous forward voltage	0.2A	V _F	0.45	0.50	0.60	0.80	Volts
Maximum DC reverse current at rated DC blocking voltage	TA=25°C	I _R	80.00		50.00		uA
	TA=125°C		30				mA
Typical junction capacitance	4.0 V, 1 MHz	C _J	18	13	12	9	pF
Typical thermal resistance	junction to mount	R _{θJM}	55				°C/W

Note:1),The thermal resistance from junction to mount,mounted on P.C.B with 5x5mm copper pads,2 OZ,FR4 PCB



SGPD220S thru SGPD2BS

Surface Mount Schottky Rectifier
Reverse Voltage 20~100V Forward Current 0.2A

Ratings and Characteristics Curves

(TA = 25°C unless otherwise noted)

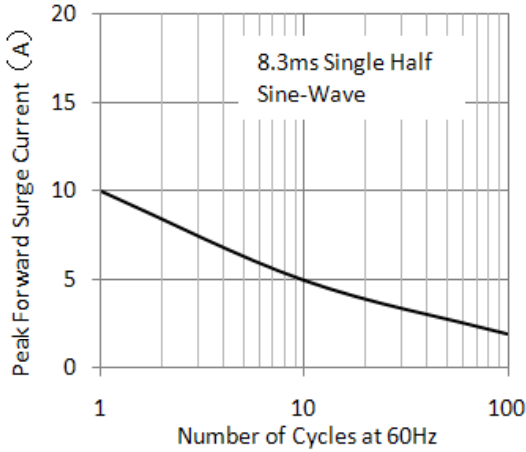

Figure 1. Maximum Non-Repetitive Peak Forward Surge Current

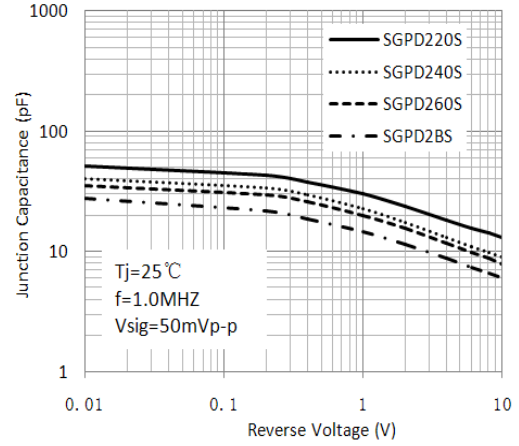

Figure 2. Typical Junction Capacitance

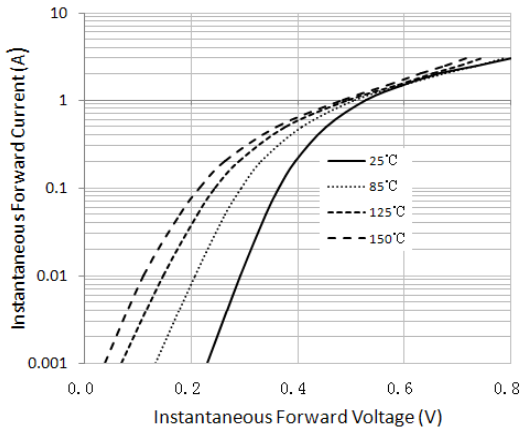

Figure 3. Typical Instantaneous Forward Characteristics (SGPD220S)

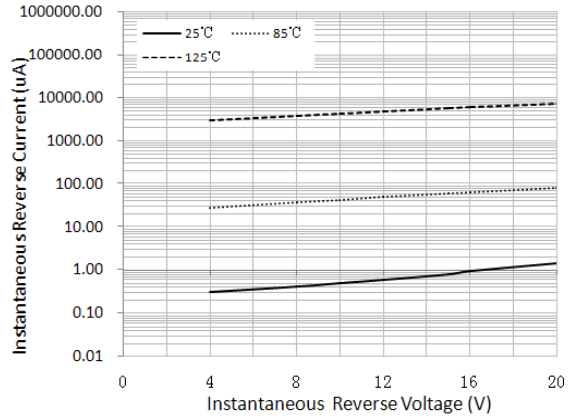

Figure 4. Typical Reverse Characteristics (SGPD220S)

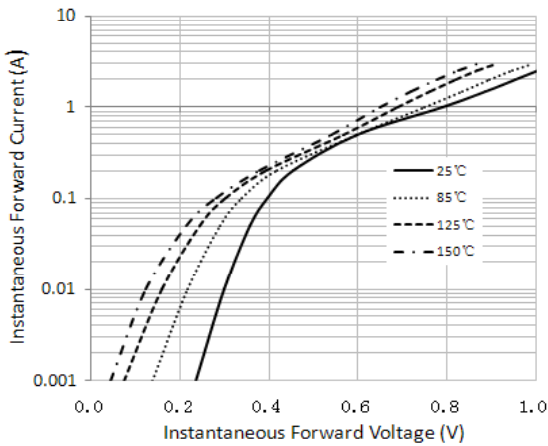

Figure 5. Typical Instantaneous Forward Characteristics (SGPD240S)

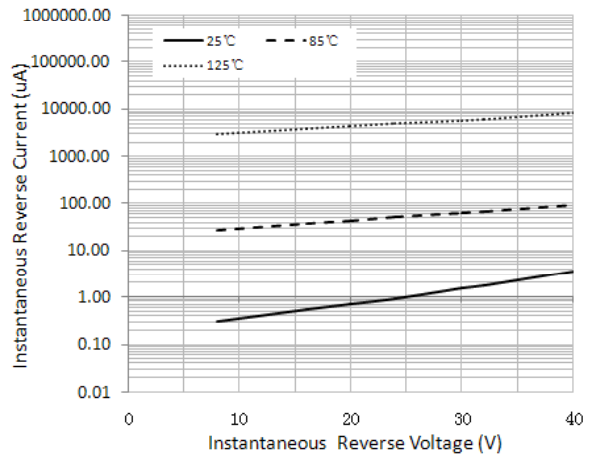

Figure 6. Typical Reverse Characteristics (SGPD240S)



SGPD220S thru SGPD2BS

Surface Mount Schottky Rectifier
Reverse Voltage 20~100V Forward Current 0.2A

Ratings and Characteristics Curves

(TA = 25°C unless otherwise noted)

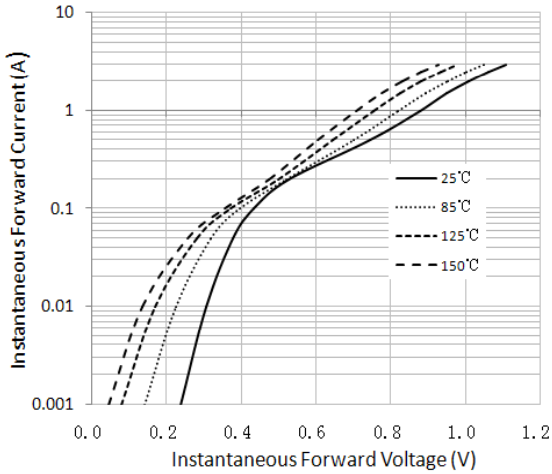

Figure 7. Typical Instantaneous Forward Characteristics (SGPD260S)

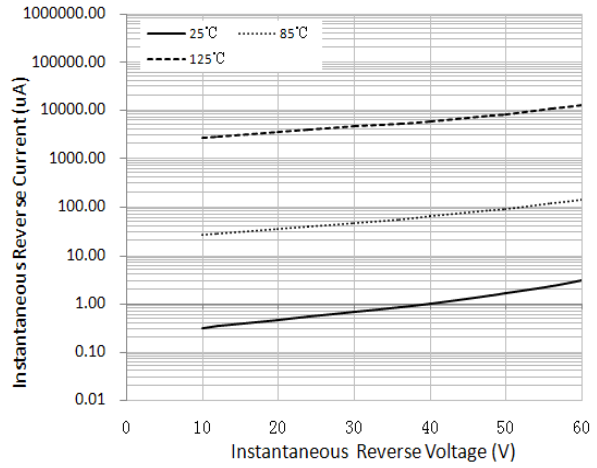

Figure 8. Typical Reverse Characteristics (SGPD260S)

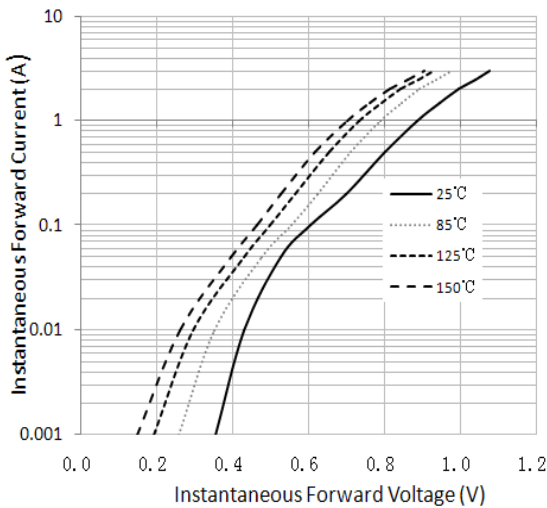

Figure 9. Typical Instantaneous Forward Characteristics (SGPD2BS)

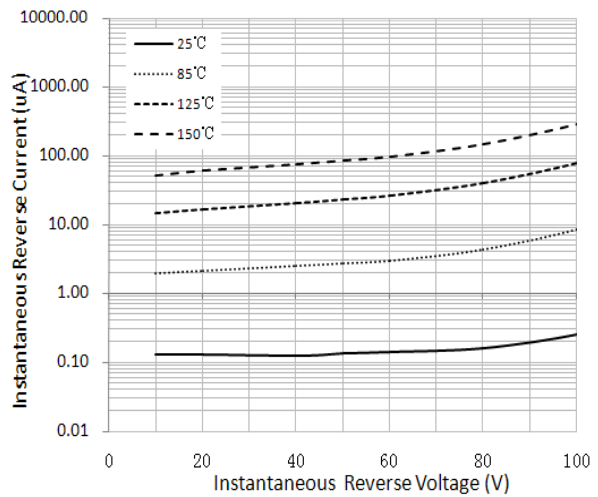
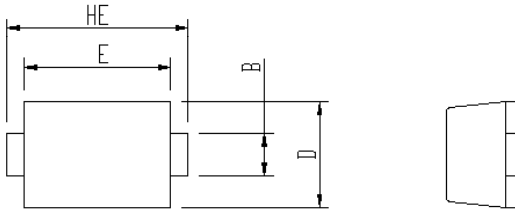
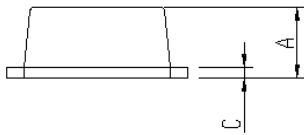

Figure 10. Typical Reverse Characteristics (SGPD2BS)

Package Outline Dimensions



Package	Unit:mm		Unit:inch	
	MIN	MAX	MIN	MAX
eSGP				
A	0.9	1.08	0.035	0.043
B	0.5	0.7	0.020	0.028
C	0.1	0.25	0.004	0.010
D	1.4	1.6	0.055	0.063
E	2.0	2.2	0.079	0.087
L	0.35	0.65	0.014	0.026
HE	2.4	2.8	0.094	0.110



Soldering footprint

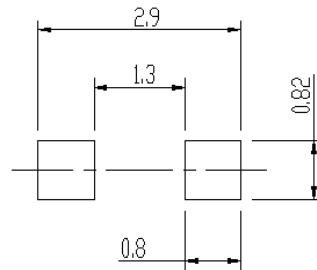
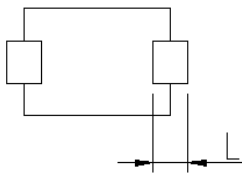

Packing Information

Packing quantities:

3000 pcs/Reel, 40 Reels/Box; 8mm Tape, 7" Reel

Tape & Reel Specification

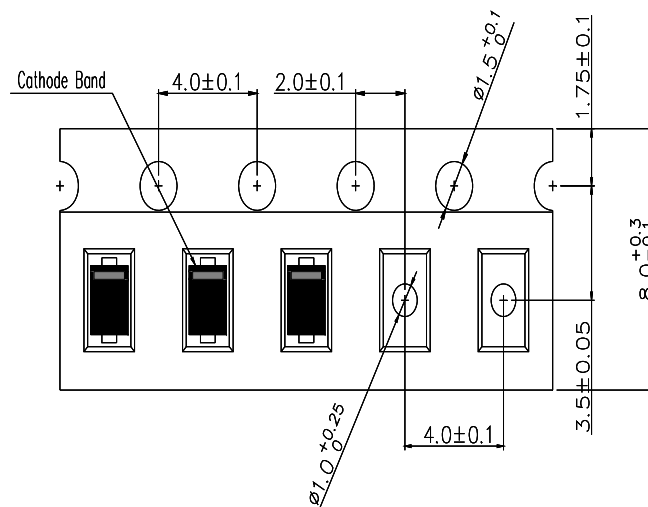



SGPD220S thru SGPD2BS

Surface Mount Schottky Rectifier
Reverse Voltage 20~100V Forward Current 0.2A

Disclaimers

These materials are intended as a reference to assist our customers in the selection of the Suzhou Good-Ark product best suited to the customer's application; they do not convey any license under any intellectual property rights, or any other rights, belonging to Suzhou Good-Ark Electronics Co., Ltd. or a third party.

Suzhou Good-Ark Electronics Co., Ltd. assumes no responsibility for any damage, or infringement of any third-party's rights, originating in the use of any product data, diagrams, charts, programs, algorithms, or circuit application examples contained in these materials.

All information contained in these materials, including product data, diagrams, charts, programs and algorithms represents information on products at the time of publication of these materials, and are subject to change by Suzhou Good-Ark Electronics Co., Ltd. without notice due to product improvements or other reasons. It is therefore recommended that customers contact Suzhou Good-Ark Electronics Co., Ltd. or an authorized Suzhou Good-Ark Electronics Co., Ltd. for the latest product information before purchasing a product listed herein. The information described here may contain technical inaccuracies or typographical errors. Suzhou Good-Ark Electronics Co., Ltd. assumes no responsibility for any damage, liability, or other loss rising from these inaccuracies or errors. Please also pay attention to information published by Suzhou Good-Ark Electronics Co., Ltd. by various means, including our website home page.
(<http://www.goodark.com>)

When using any or all of the information contained in these materials, including product data, diagrams, charts, programs, and algorithms, Please be sure to evaluate all information as a total system before making a final decision on the applicability of the information and products. Suzhou Good-Ark Electronics Co., Ltd. assumes no responsibility for any damage, liability or other loss resulting from the information contained herein.

The prior written approval of Suzhou Good-Ark Electronics Co., Ltd. is necessary to reprint or reproduce in whole or in part these materials.

Please contact Suzhou Good-Ark Electronics Co., Ltd. or an authorized distributor for further details on these materials or the products contained herein.