

Surface Mount Resettable PTCs

SCF2920 Series

Description

The SCF2920 Series PTC provides surface mount over-current protection for applications where space is at a premium and resettable protection is desired.

Features

- ◆ RoHS compliant, Lead-Free and Halogen-Free
- ◆ Fast time-to-trip
- ◆ Compact design saves board space
- ◆ Low resistance
- ◆ Low-profile

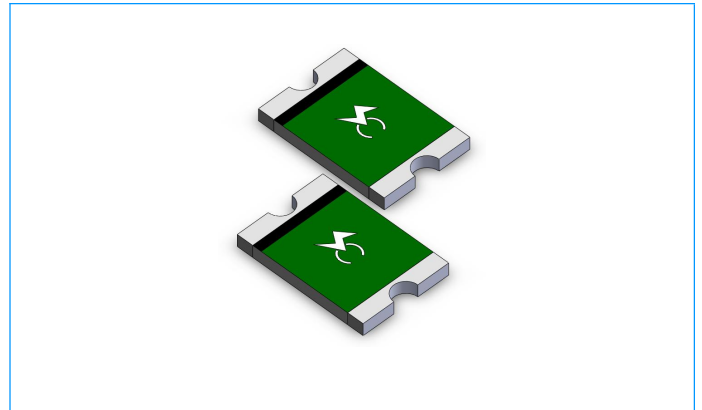

Applications

- ◆ PC motherboard - plug and play protection
- ◆ Mobile phones - battery and port protection
- ◆ Game console port protection
- ◆ USB peripherals
- ◆ Disk drive
- ◆ PDAS / digital cameras
- ◆ Power ports
- ◆ General electronics

Electrical Parameters

Part Number	Hold Current	Trip Current	Rated Voltage	Max Current	Typical Power	Maximum Time To Trip		Resistance	
	I_{hold} (A)	I_{trip} (A)	V_{max} (Vdc)	I_{max} (A)	$P_{dtyp.}$ (W)	Current (A)	Time (Sec.)	R_{min} (Ω)	R_{1max} (Ω)
SCF030-2920R	0.30	0.60	60	100	1.5	1.5	3.0	1.000	4.800
SCF050-2920R	0.50	1.00	60	100	1.5	2.5	4.0	0.300	1.400
SCF075-2920R	0.75	1.50	33	100	1.5	8.0	0.3	0.180	1.000
SCF075-60-2920R	0.75	1.50	60	100	1.5	8.0	0.3	0.180	1.000
SCF100-2920R	1.10	2.20	33	100	1.5	8.0	0.5	0.090	0.410
SCF100-60-2920R	1.10	2.20	60	100	1.5	8.0	0.5	0.090	0.410
SCF125-2920R	1.25	2.50	33	100	1.5	8.0	2.0	0.050	0.250
SCF150-2920R	1.50	3.00	33	100	1.5	8.0	2.0	0.050	0.230
SCF185-2920R	1.85	3.70	33	100	1.5	8.0	2.5	0.040	0.150
SCF200-2920R	2.00	4.00	16	100	1.5	8.0	4.5	0.035	0.120
SCF200-24-2920R	2.00	4.00	24	100	1.5	8.0	5.0	0.035	0.120
SCF250-2920R	2.50	5.00	16	100	1.5	8.0	16.0	0.025	0.085
SCF260-2920R	2.60	5.20	6	100	1.5	8.0	20.0	0.020	0.075
SCF260-24-2920R	2.60	5.20	24	100	1.5	8.0	20.0	0.020	0.075
SCF300-2920R	3.00	5.20	6	100	1.5	8.0	25.0	0.010	0.048
SCF300-15-2920R	3.00	5.20	15	100	1.5	8.0	25.0	0.010	0.048
SCF300-24-2920R	3.00	5.20	24	100	1.5	8.0	25.0	0.010	0.048
SCF500-16-2920R	5.00	10.0	16	100	1.5	20.0	5.0	0.005	0.025

I_{hold} = Hold current: maximum current device will pass without tripping in 23°C still air.

I_{trip} = Trip current: minimum current at which the device will trip in 23°C still air.

V_{max} = Maximum voltage device can withstand without damage at rated current (I_{max})

I_{max} = Maximum fault current device can withstand without damage at rated voltage (V_{max})

$P_{dtyp.}$ = Power dissipated from device when in the tripped state at 23°C still air.

R_{min} = Minimum resistance of device in initial (un-soldered) state.

R_{1max} = Maximum resistance of device at 23°C measured one hour after tripping.

Caution: Operation beyond the specified rating may result in damage and possible arcing and flame.

Surface Mount Resettable PTCs

SCF2920 Series

Temperature Derating Chart – I_{hold} (A)

Average Time Current Curves

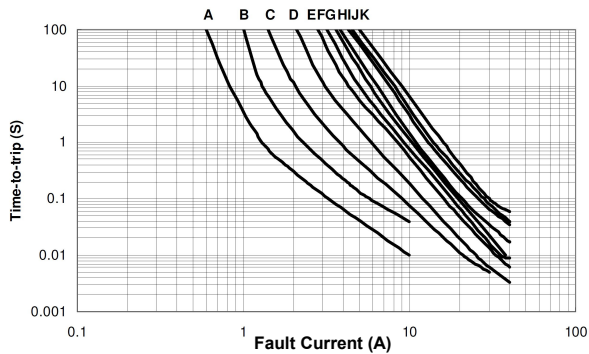

- A= SCF030-2920R
- B= SCF050-2920R
- C= SCF075-2920R /SCF075-60-2920R
- D= SCF100-2920R /SCF100-60-2920R
- E= SCF125-2920R
- F= SCF150-2920R
- G= SCF185-2920R
- H= SCF200-2920R /SCF200-24-2920R
- I= SCF250-2920R
- J= SCF260-2920R /SCF260-24-2920R
- K= SCF300-2920R /SCF300-15-2920R /SCF300-24-2920R

Temperature Derating Curve

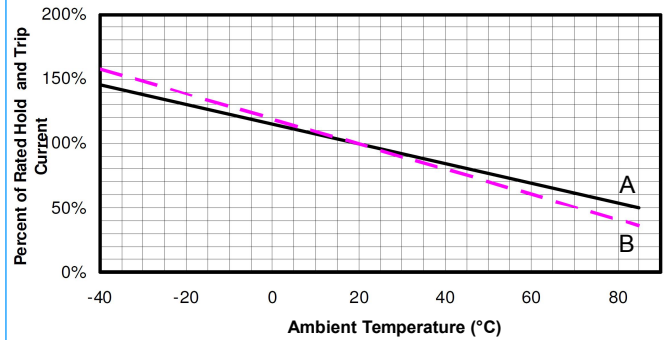

- A=SCF125-2920R ~ SCF300-2920R
- B=SCF030-2920R ~ SCF100-2920R

Material Specifications

Terminal pad material	Pure Tin
Soldering Characteristics	Meets EIA specification RS 186-9E, ANSI/J-std-002 Category 3

Soldering Parameters

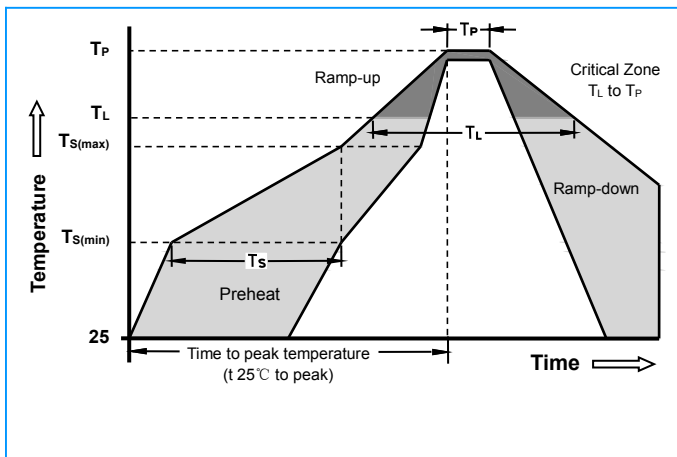

Profile Feature	Pb-Free Assembly
Average Ramp-Up Rate (T _s max to T _p)	3°C/second max.
Preheat : Temperature Min (T _s min) Temperature Max (T _s max) Time (T _s min to T _s max)	150°C 200°C 60-180 seconds
Time maintained above: Temperature(T _L) Time (T _L)	217°C 60-150 seconds
Peak/Classification Temperature(T _p):	260°C
Time within 5°C of actual peak: Temperature	20-40 seconds
Ramp-down Rate:	6°C/ second max.
Time 25°C to Peak Temperature	8 minutes max.

Note: All temperatures refer to of the package, measured on the package body surface.

Solder reflow

Due to "Lead Free" nature, Temperature and Dwelling time for the soldering zone is higher than those for Regular. This may cause damage to other components.

1. Recommended max past thickness > 0.25mm.
2. Devices can be cleaned using standard methods and aqueous solvent.
3. Rework use standard industry practices.
4. Storage Environment : < 30°C/ 60%RH

Caution:

1. If reflow temperatures exceed the recommended profile, devices may not meet the performance requirements.
2. Devices are not designed to be wave soldered to the bottom side of the board.

Surface Mount Resettable PTCs

SCF2920 Series

Part Numbering

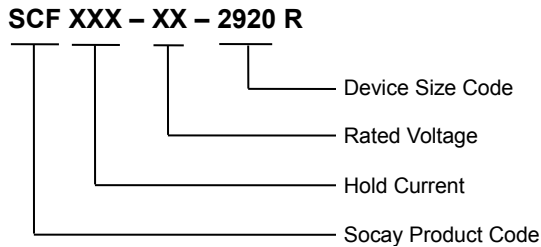

Part Marking

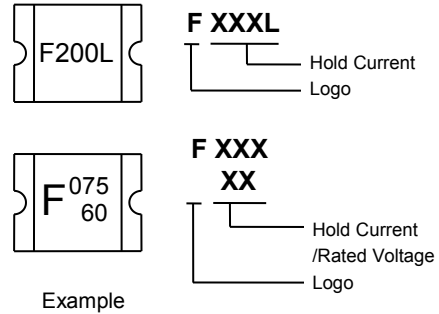

Pad Layouts Unit: mm

The dimension in the table below provide the recommended pad layout for each SCF2920 device

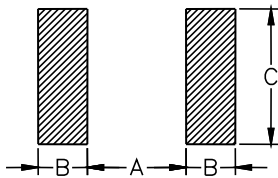

Device	A	B	C
	Nominal	Nominal	Nominal
2920 Series	5.10	2.30	5.60

Dimensions Unit: mm

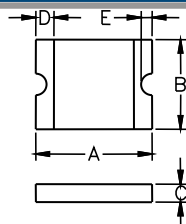

Part Number	A		B		C		D		E	
	Min.	Max.	Min.	Max.	Min.	Max.	Min.	Max.	Min.	Max.
SCF030-2920R	6.73	7.98	4.80	5.44	0.60	1.15	0.50	1.20	0.50	0.90
SCF050-2920R	6.73	7.98	4.80	5.44	0.60	1.15	0.50	1.20	0.50	0.90
SCF075-2920R	6.73	7.98	4.80	5.44	0.40	1.15	0.50	1.20	0.50	0.90
SCF075-60-2920R	6.73	7.98	4.80	5.44	0.60	1.15	0.50	1.20	0.50	0.90
SCF100-2920R	6.73	7.98	4.80	5.44	0.40	1.00	0.50	1.20	0.50	0.90
SCF100-60-2920R	6.73	7.98	4.80	5.44	0.40	1.70	0.50	1.20	0.50	0.90
SCF125-2920R	6.73	7.98	4.80	5.44	0.40	0.90	0.50	1.20	0.50	0.90
SCF150-2920R	6.73	7.98	4.80	5.44	0.40	0.90	0.50	1.20	0.50	0.90
SCF185-2920R	6.73	7.98	4.80	5.44	0.30	0.90	0.50	1.20	0.50	0.90
SCF200-2920R	6.73	7.98	4.80	5.44	0.30	0.90	0.50	1.20	0.50	0.90
SCF200-24-2920R	6.73	7.98	4.80	5.44	0.20	0.80	0.50	1.20	0.50	0.90
SCF250-2920R	6.73	7.98	4.80	5.44	0.30	0.90	0.50	1.20	0.50	0.90
SCF260-2920R	6.73	7.98	4.80	5.44	0.30	0.90	0.50	1.20	0.50	0.90
SCF260-24-2920R	6.73	7.98	4.80	5.44	0.65	1.15	0.50	1.20	0.50	0.90
SCF300-2920R	6.73	7.98	4.80	5.44	0.40	0.90	0.50	1.20	0.50	0.90
SCF300-15-2920R	6.73	7.98	4.80	5.44	0.40	1.15	0.50	1.20	0.50	0.90
SCF300-24-2920R	6.73	7.98	4.80	5.44	0.65	1.15	0.50	1.20	0.50	0.90
SCF500-16-2920R	6.73	7.98	4.80	5.44	0.40	1.50	0.50	1.20	0.50	0.90

Surface Mount Resettable PTCs

SCF2920 Series

Packaging

Part Number	Packaging Option	Quantity
SCF030-2920R	Tape & Reel -16mm/7"tape	2000
SCF050-2920R	Tape & Reel -16mm/7"tape	2000
SCF075-2920R	Tape & Reel -16mm/7"tape	2000
SCF075-60-2920R	Tape & Reel -16mm/7"tape	2000
SCF100-2920R	Tape & Reel -16mm/7"tape	2000
SCF100-60-2920R	Tape & Reel -16mm/7"tape	1000
SCF125-2920R	Tape & Reel -16mm/7"tape	2000
SCF150-2920R	Tape & Reel -16mm/7"tape	2000
SCF185-2920R	Tape & Reel -16mm/7"tape	2000
SCF200-2920R	Tape & Reel -16mm/7"tape	2000
SCF200-24-2920R	Tape & Reel -16mm/7"tape	2000
SCF250-2920R	Tape & Reel -16mm/7"tape	2000
SCF260-2920R	Tape & Reel -16mm/7"tape	2000
SCF260-24-2920R	Tape & Reel -16mm/7"tape	2000
SCF300-2920R	Tape & Reel -16mm/7"tape	2000
SCF300-15-2920R	Tape & Reel -16mm/7"tape	2000
SCF300-24-2920R	Tape & Reel -16mm/7"tape	2000
SCF500-16-2920R	Tape & Reel -16mm/7"tape	2000

Tape and Reel Specifications

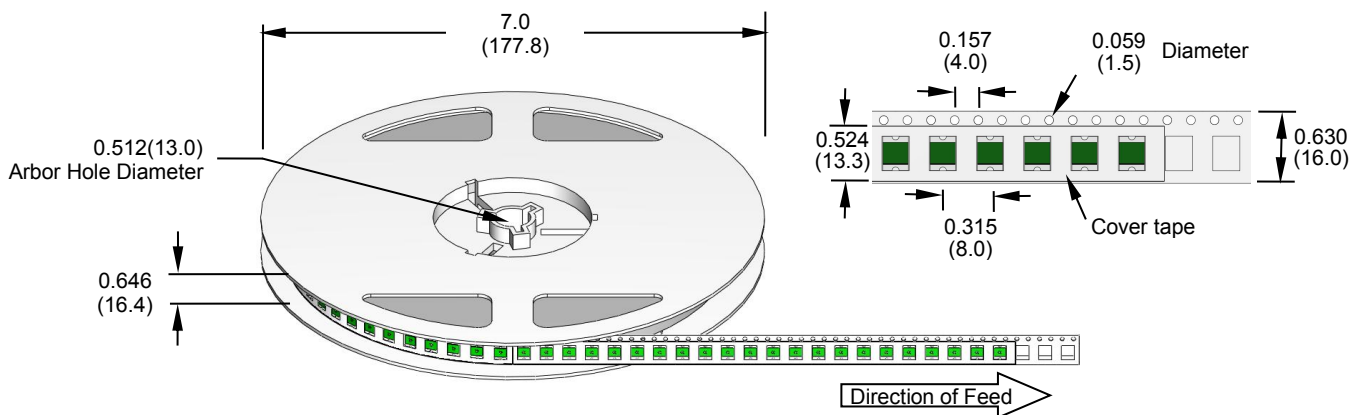

Dimensions are in inches
(and millimeters)

Warning



- ◆ Operation beyond the specified maximum ratings or improper use may result in damage and possible electrical arcing and/or flame.
- ◆ PPTC device are intended for occasional over-current protection. Application for repeated over-current condition and/or prolonged trip are not anticipated.
- ◆ Avoid contact of PPTC device with chemical solvent. Prolonged contact will damage the device performance.